

# Hurricane

COLLECTION



ARMONIE

ARMONIE

# Hurricane

IL NATURALE EQUILIBRIO DELLA PIETRA

**MATERICA, RAFFINATA, INNOVATIVA.**

Hurricane accosta l'eleganza della lavagna nera alla bellezza minimalista dell'ardesia.

Frutto della sperimentazione grafica è una nuova superficie impreziosita da una tipica matrice granulare che mitiga l'aria severa e compatta della roccia sedimentaria conferendo ad Hurricane un aspetto dall'indiscutibile ricercatezza.

The natural balance of stone  
L'équilibre naturel de la pierre  
Das natürliche Gleichgewicht des Steins

**Textured, refined, innovative.**  
Hurricane combines the elegance of black shale with the minimalist beauty of slate. The result of graphical experimentation, this is a new surface with an attractive granular texture that contrasts the sombre and compact appearance of the sedimentary rock, giving Hurricane a look of undisputable elegance.

**Matiérisme, raffinement, innovation.**  
Hurricane allie l'élégance du tableau noir à la beauté minimaliste de l'ardoise. Le résultat de l'expérimentation graphique est une nouvelle surface agrémentée d'une matrice à grains typique qui atténue l'apparence sévère et compacte de la roche sédimentaire et donne à Hurricane un aspect d'un raffinement incontestable.

**Materialistisch, raffiniert, innovativ.**  
Hurricane verbindet die Eleganz der schwarzen Schiefertafel mit der minimalistischen Schönheit des Schiefergesteins. Das Ergebnis der grafischen Experimente ist eine neue Oberfläche, die mit einer typischen körnigen Matrix veredelt ist, die die strenge und kompakte Wirkung des Sedimentgesteins abmildert und Hurricane ein unbestreitbar erhabenes Aussehen verleiht.





Riv\_Hurricane Silver - Smoke  
Pav\_Hurricane Smoke



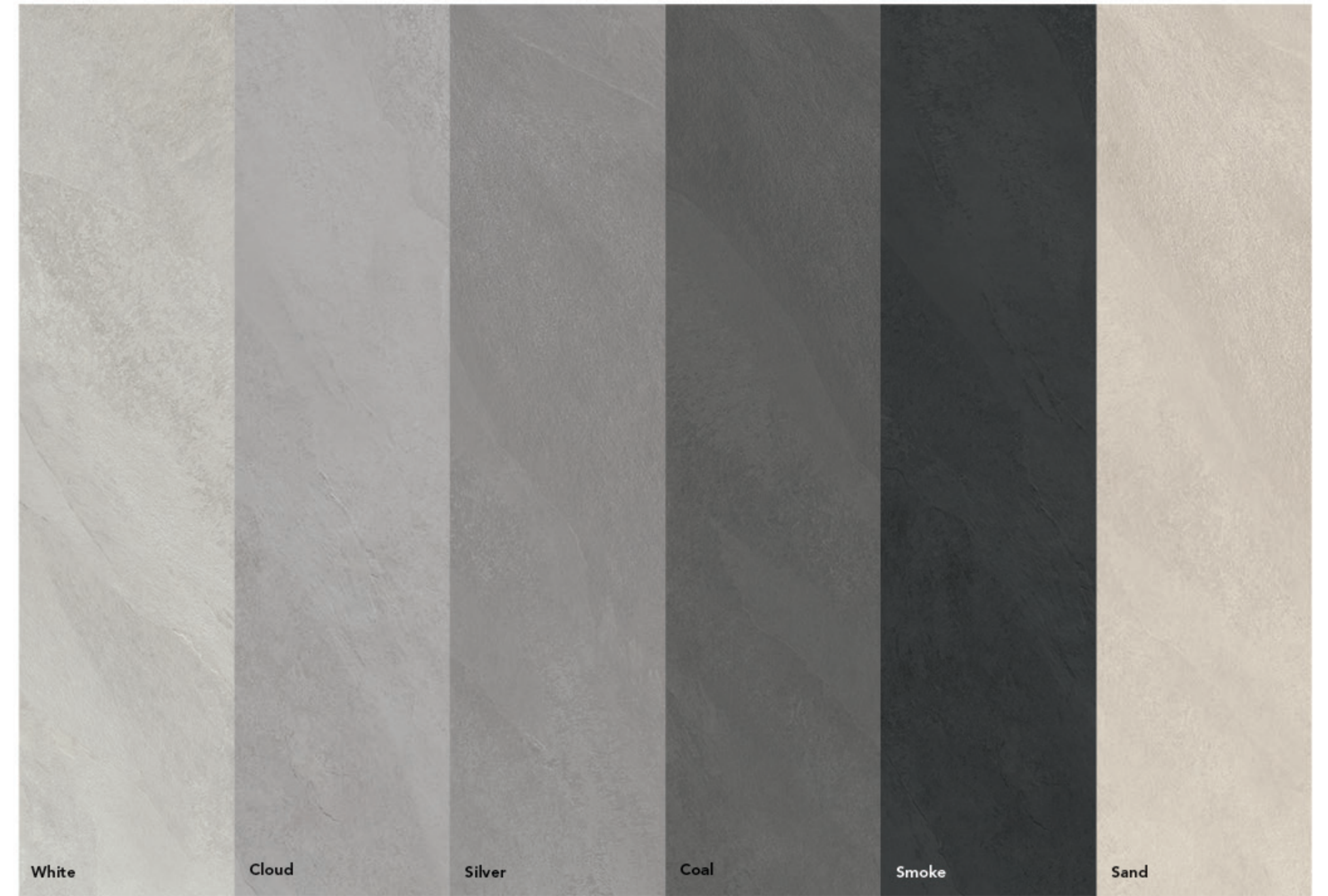

# Hurricane

Gres in massa  
 Rettificato - Rectified - Rectifié - Rektifiziert  
 R10 B - Grip R11 C

UNI EN 14411 - G Bla

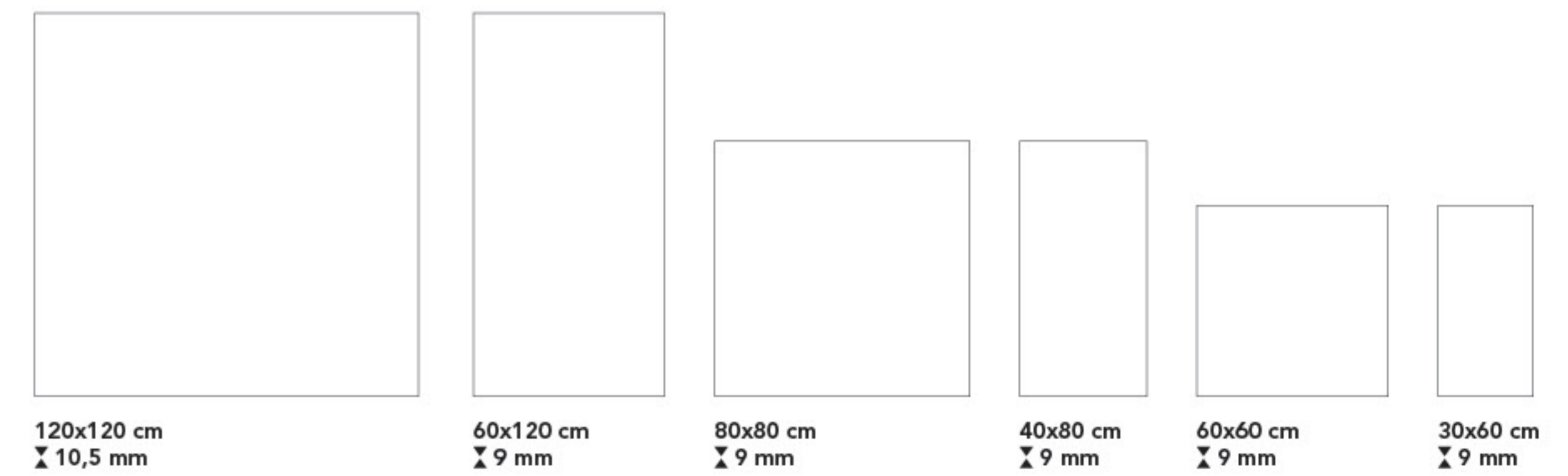

Riv\_Hurricane Inserto Arkigarden White - Cloud  
 Pav\_Hurricane Coal

# Hurricane



## WHITE

- 0447155 120x120
- 0447001 60x120
- 0447021 80x80
- 0447025 40x80
- 0447005 60x60
- 0447009 60x60 Grip
- 0447013 30x60
- 0447017 30x60 Grip



## CLOUD

- 0447080 60x120
- 0447086 80x80
- 0447088 40x80
- 0447082 60x60
- 0447090 60x60 Grip
- 0447084 30x60
- 0447092 30x60 Grip



## SILVER

- 0447156 120x120
- 0447002 60x120
- 0447022 80x80
- 0447026 40x80
- 0447006 60x60
- 0447010 60x60 Grip
- 0447014 30x60
- 0447018 30x60 Grip



## COAL

- 0447081 60x120
- 0447087 80x80
- 0447089 40x80
- 0447083 60x60
- 0447091 60x60 Grip
- 0447085 30x60
- 0447093 30x60 Grip



## SMOKE

- 0447158 120x120
- 0447003 60x120
- 0447023 80x80
- 0447027 40x80
- 0447007 60x60
- 0447011 60x60 Grip
- 0447015 30x60
- 0447019 30x60 Grip



## SAND

- 0447157 120x120
- 0447004 60x120
- 0447024 80x80
- 0447028 40x80
- 0447008 60x60
- 0447012 60x60 Grip
- 0447016 30x60
- 0447020 30x60 Grip



# Hurricane

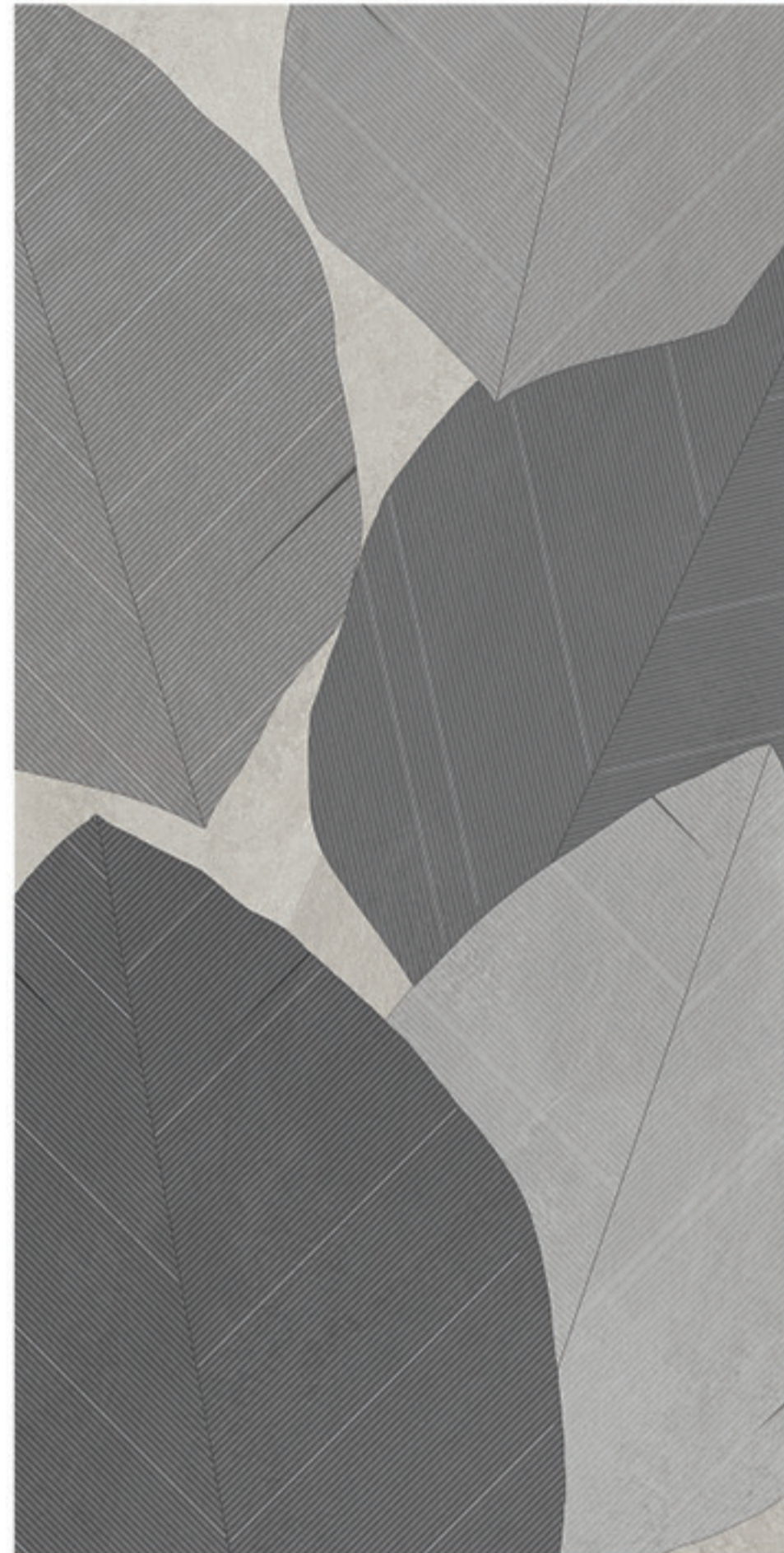

INSERTO ARKIGARDEN WHITE

0447144 60x120

Abbinabile a / Matching with / Peut s'associer avec / Kombinierbar mit

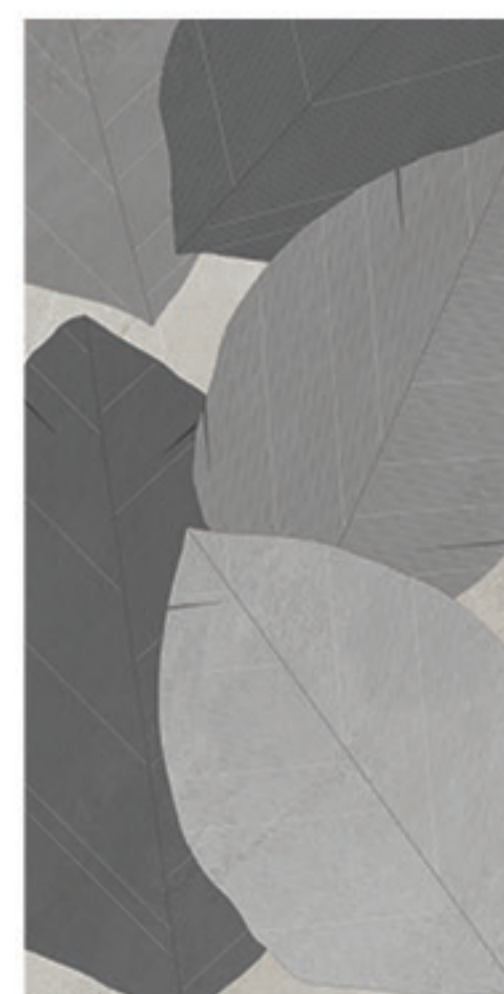

0447037 MURETTO WHITE  
30x60



0447038 MURETTO SILVER  
30x60



0447039 MURETTO SMOKE  
30x60



0447099 MURETTO CLOUD  
30x60



0447100 MURETTO COAL  
30x60



0447040 MURETTO SAND  
30x60

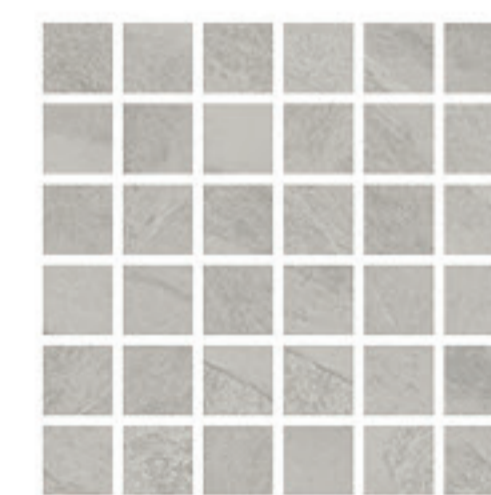

0447033 MOSAICO WHITE  
30x30

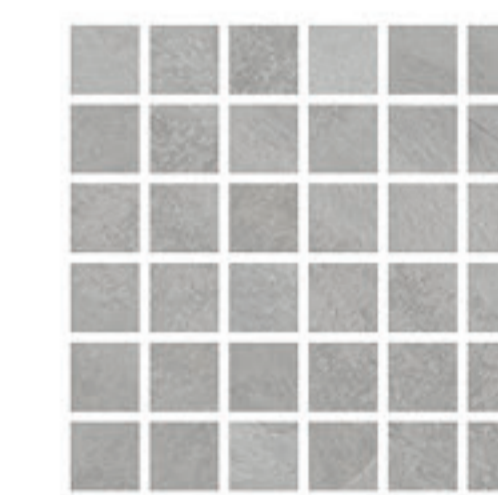

0447097 MOSAICO CLOUD  
30x30

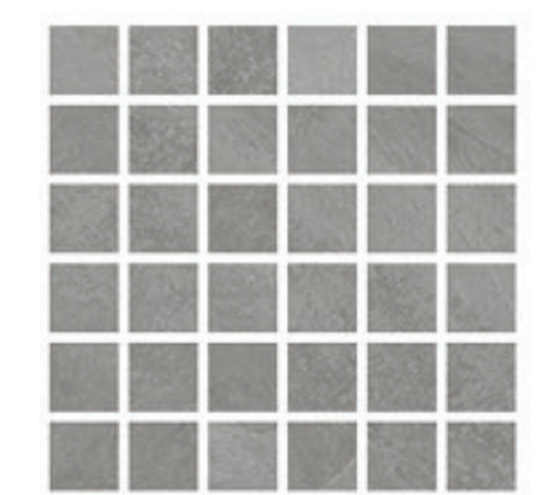

0447034 MOSAICO SILVER  
30x30

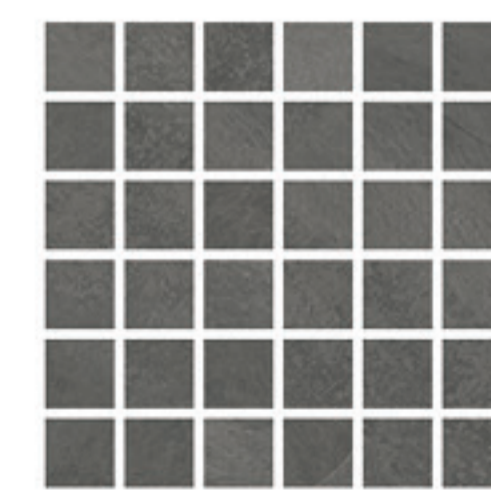

0447098 MOSAICO COAL  
30x30

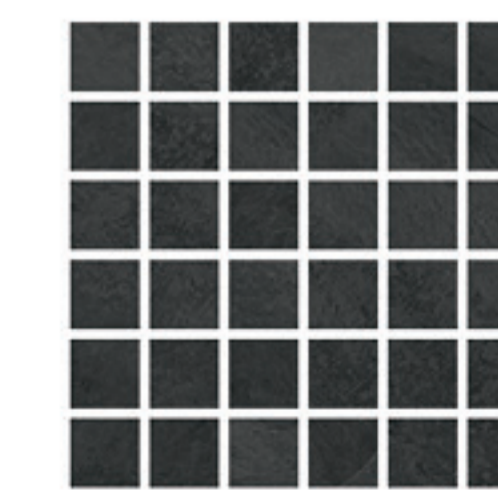

0447035 MOSAICO SMOKE  
30x30

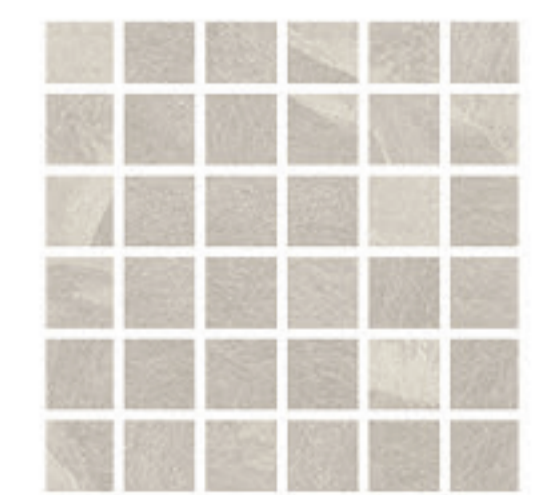

0447036 MOSAICO SAND  
30x30

# Deco Art



0451031 RAIN FOREST  
120x120  
Composizione: 2 pz. A+B - 60x120



0451037 TEMPTATION  
120x120  
Composizione: 2 pz. A+B - 60x120



0451015 EDEN  
120x120  
Composizione: 2 pz. A+B - 60x120



0451011 POP GARDEN  
120x120  
Composizione: 2 pz. A+B - 60x120



0451040 BAMBU SKETCH  
120x120  
Composizione: 2 pz. A+B - 60x120



0451042 WONDERLAND  
120x120  
Composizione: 2 pz. A+B - 60x120



0451064 WILDFLOWERS  
120x120  
Composizione: 2 pz. A+B - 60x120



0451036 LILIUM  
120x120  
Composizione: 2 pz. A+B - 60x120



0451012 GOLDEN LEAVES  
120x120  
Composizione: 2 pz. A+B - 60x120



0451001 SAVAGE  
120x120  
Composizione: 2 pz. A+B - 60x120



0451038 FANCY WALL  
120x120  
Composizione: 2 pz. A+B - 60x120



0451033 PURPLE CHIC  
120x120  
Composizione: 2 pz. A+B - 60x120

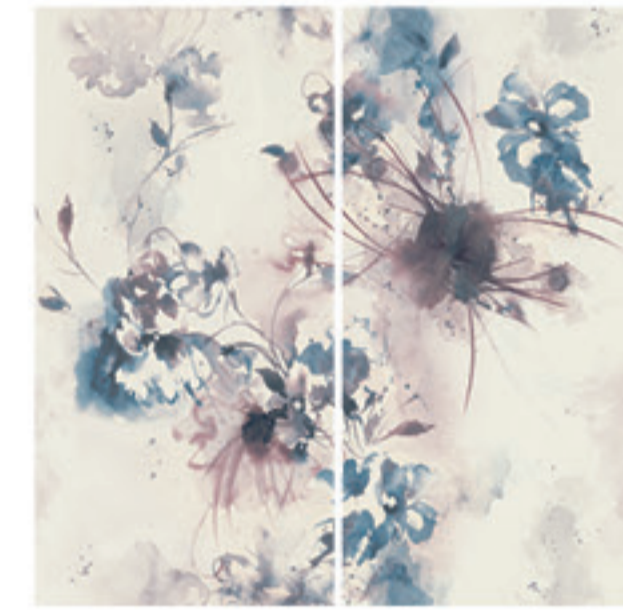

0451016 MEMORIE  
120x120  
Composizione: 2 pz. A+B - 60x120



0451003 POETICA  
120x120  
Composizione: 2 pz. A+B - 60x120



0451014 BLACK FLOWERS  
120x120  
Composizione: 2 pz. A+B - 60x120



0451004 ROMANCE  
60x120



0451059 CLOROFILLA  
120x120  
Composizione: 2 pz. A+B - 60x120



0451039 MACROPHILLA  
120x120  
Composizione: 2 pz. A+B - 60x120



0451035 COTTON GARDEN  
120x120  
Composizione: 2 pz. A+B - 60x120



0451034 WILD ATELIER  
120x120  
Composizione: 2 pz. A+B - 60x120



0451002 CHARME  
120x120  
Composizione: 2 pz. A+B - 60x120



0451013 GRAFFITI  
120x120  
Composizione: 2 pz. A+B - 60x120

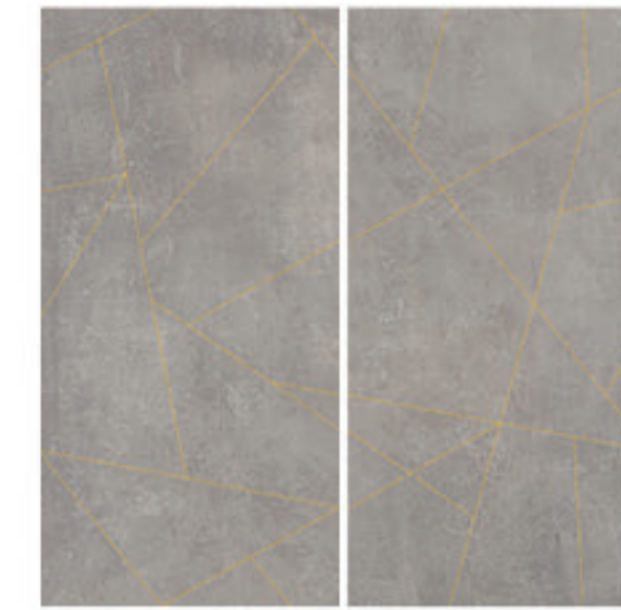

0451017 GOLD LINE CEMENTO  
120x120  
Composizione: 2 pz. A+B - 60x120



0451018 GOLD LINE ARDESIA  
120x120  
Composizione: 2 pz. A+B - 60x120



0451063 VENUS  
120x120  
Composizione: 2 pz. A+B - 60x120

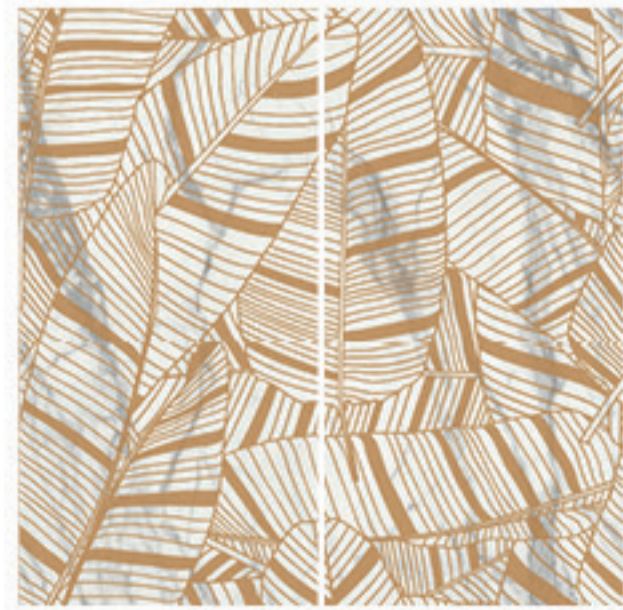

0451032 INCANTO  
120x120  
Composizione: 2 pz. A+B - 60x120

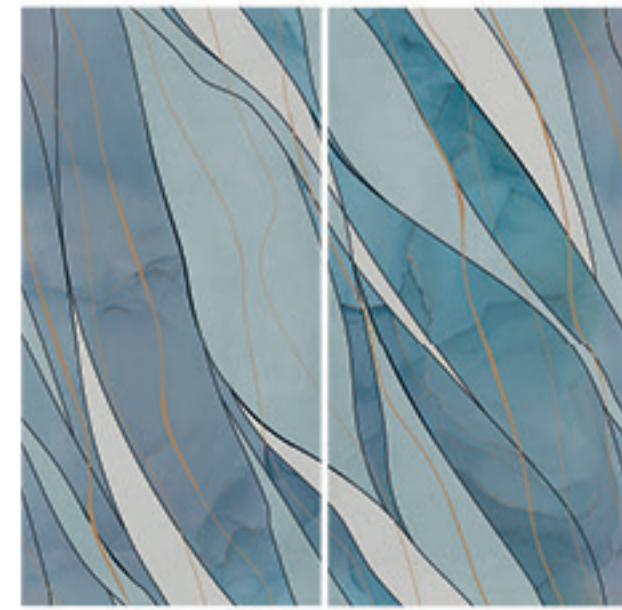

0451041 ICELAND  
120x120  
Composizione: 2 pz. A+B - 60x120



0451005 PAINT  
60x120



Pav\_Hurricane 2.0 Silver

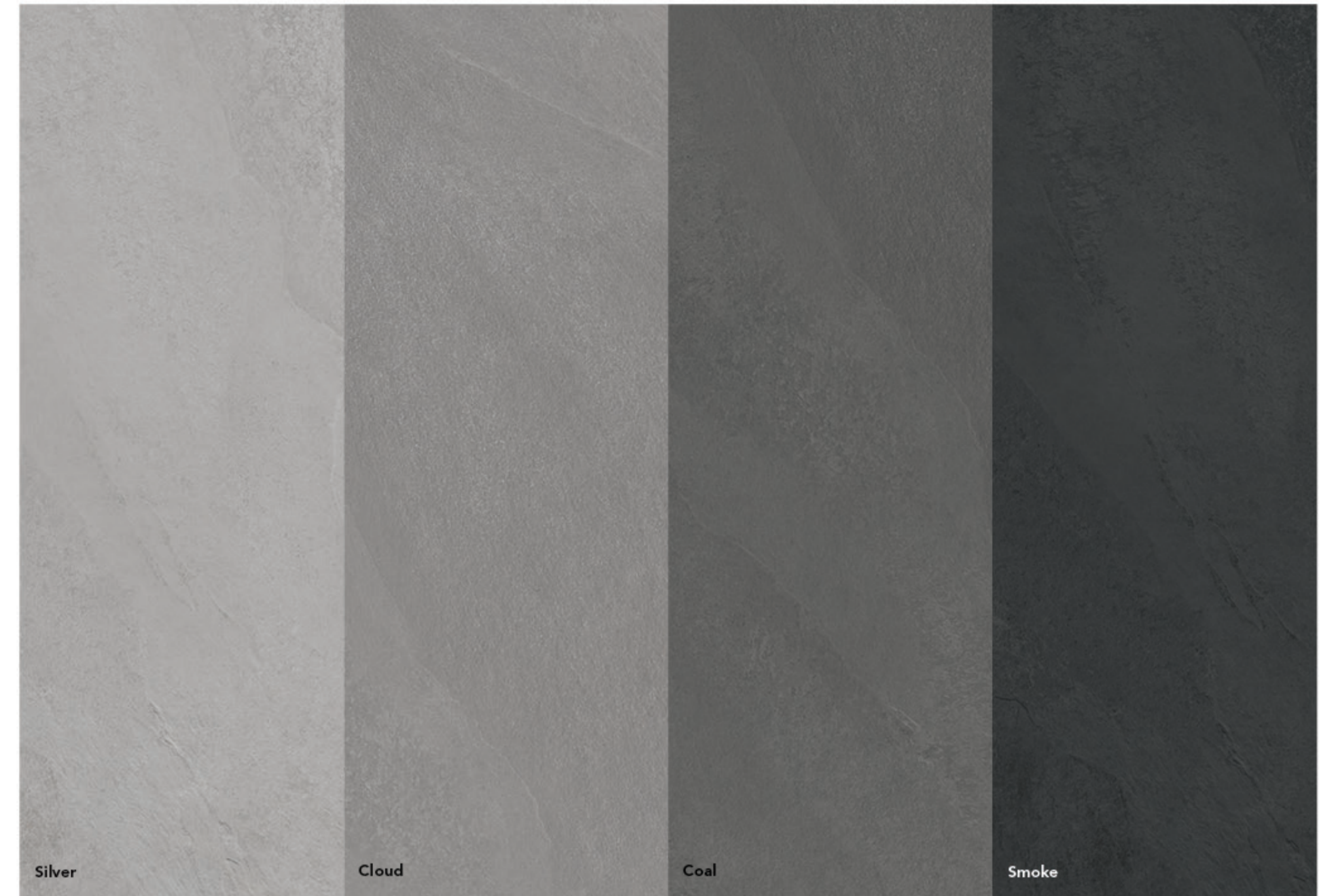

## Hurricane 2.0

Gres in massa  
Rettificato - Rectified - Rectifié - Rektifiziert

UNI EN 14411 - G Bla



60x120 cm  
X 20 mm



60x60 cm  
X 20 mm

# Hurricane 2.0



**CLOUD**  
0447074 60x120  
0447076 60x60



**SILVER**  
0447057 60x120  
0447078 60x60



**COAL**  
0447075 60x120  
0447077 60x60



**SMOKE**  
0447058 60x120  
0447079 60x60



Pav Esterno\_Hurricane 2.0 Silver  
Pav Interno\_Hurricane Silver



Riv\_Hurricane White - Struttura Lace White  
Pav\_Hurricane White

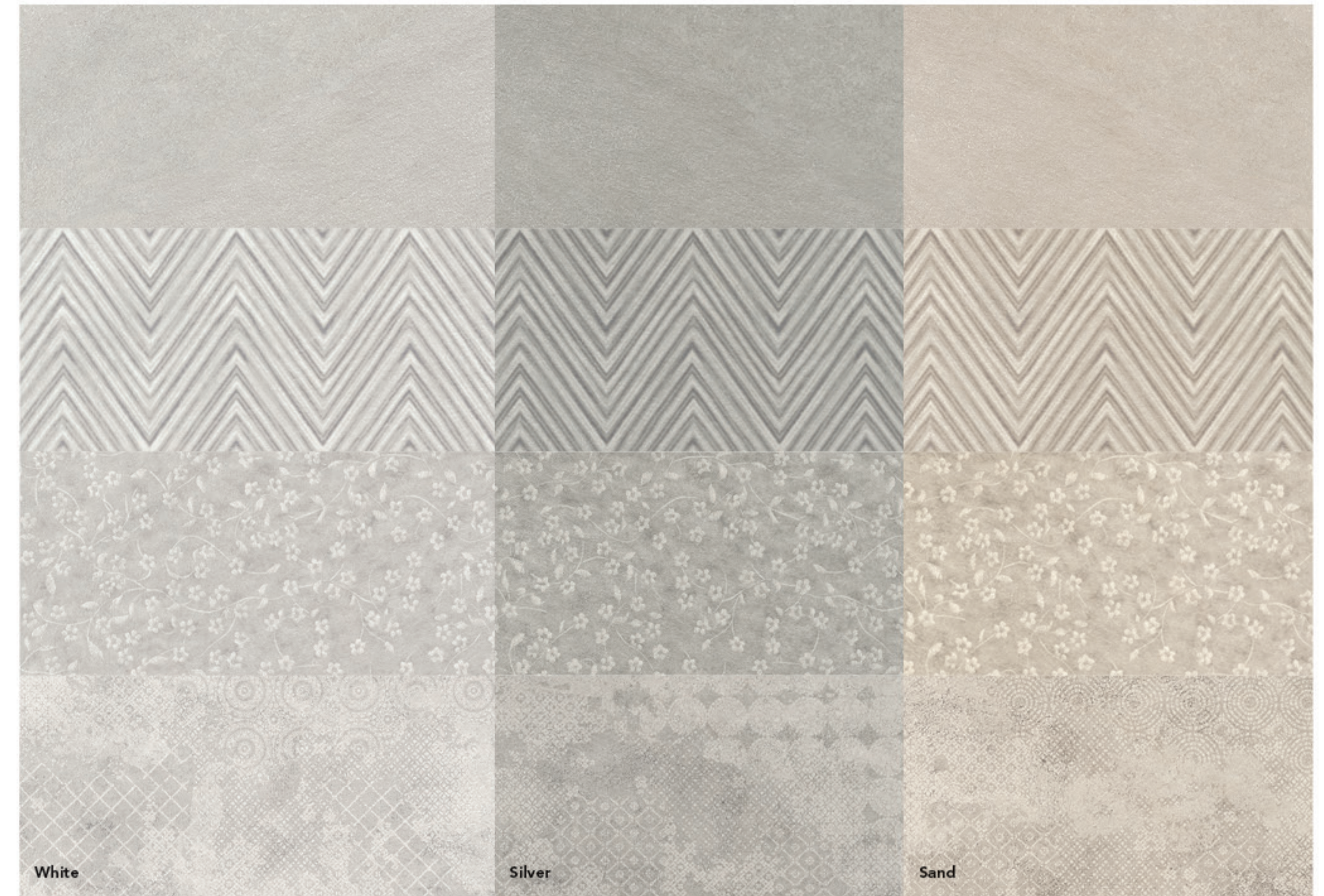

## Hurricane

Rivestimento in pasta bianca  
Rettificato - Rectified - Rectifié - Rektifiziert

UNI EN 14411 - BIII



33,3x100 cm  
7 mm



Riv\_Hurricane Silver - Mosaico Brick Silver - Struttura Daisy Silver  
Pav\_Hurricane Silver

# Hurricane



0447045 WHITE  
33,3x100



0447048 STRUTTURA PEAK WHITE  
33,3x100



0447051 STRUTTURA DAISY WHITE  
33,3x100



0447063 MOSAICO BRICK WHITE  
33,3x33,3



0447054 STRUTTURA LACE WHITE 1/2/3  
33,3x100



0447046 SILVER  
33,3x100

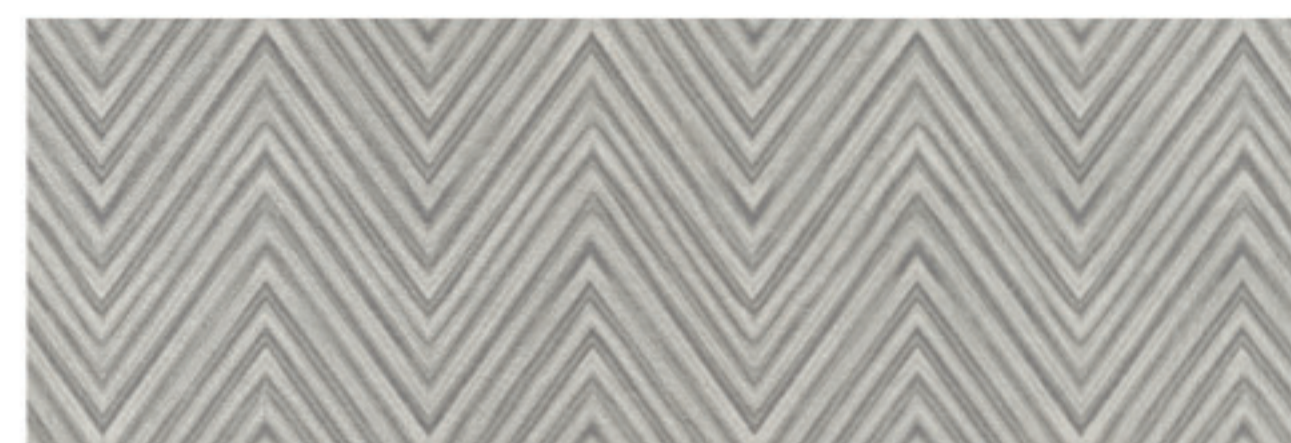

0447049 STRUTTURA PEAK SILVER  
33,3x100

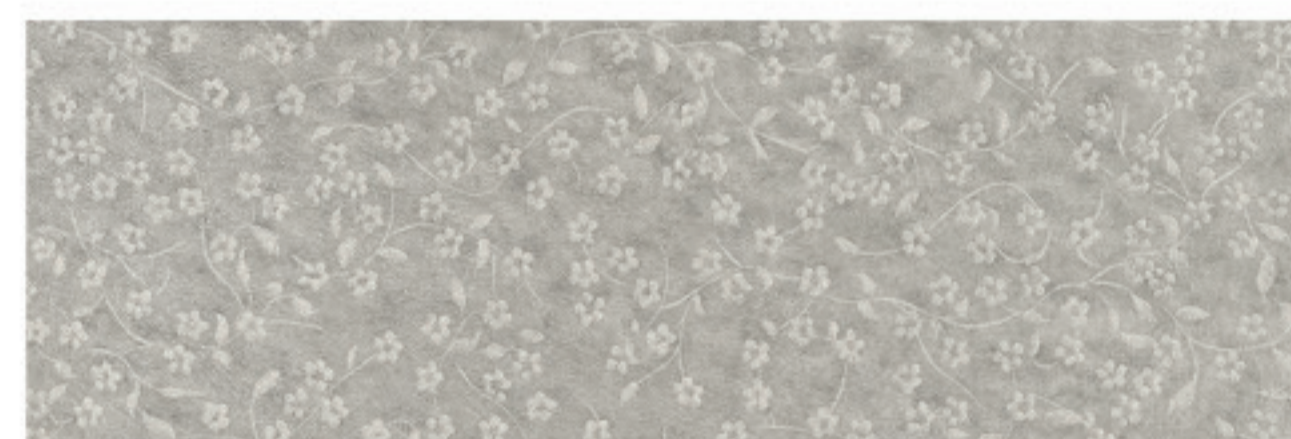

0447052 STRUTTURA DAISY SILVER  
33,3x100

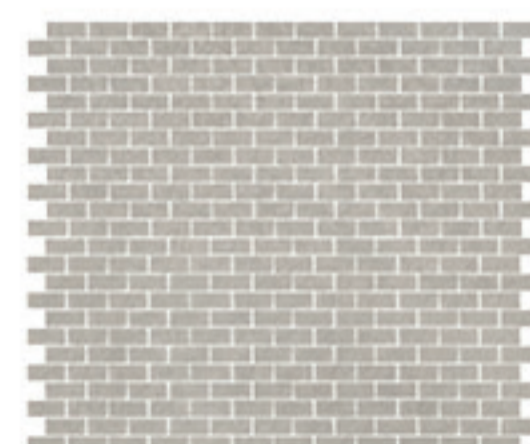

0447064 MOSAICO BRICK SILVER  
33,3x33,3



0447055 STRUTTURA LACE SILVER 1/2/3  
33,3x100

# Hurricane



0447047 SAND  
33,3x100



0447050 STRUTTURA PEAK SAND  
33,3x100



0447053 STRUTTURA DAISY SAND  
33,3x100

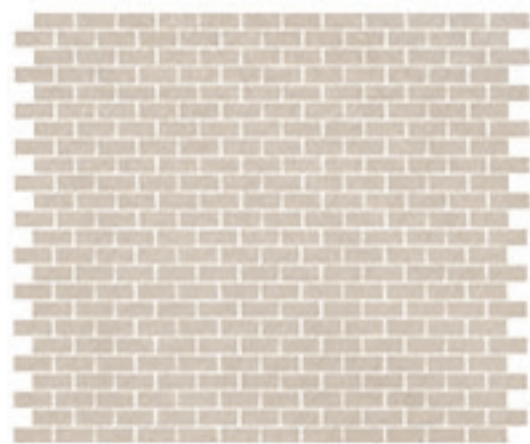

0447065 MOSAICO BRICK SAND  
33,3x33,3

0273043 BACCHETTA BONE MATT  
1x100 - spessore 6 mm

Abbinabile a / Matching with / Peut s'associer avec / Kombinierbar mit



WHITE



SAND



0447056 STRUTTURA LACE SAND 1/2/3  
33,3x100

0273044 BACCHETTA GREY MATT  
1x100 - spessore 6 mm

Abbinabile a / Matching with / Peut s'associer avec / Kombinierbar mit



GREY



Riv\_Hurricane\_Bacchetta Bone Matt  
Pav\_Hurricane Sand







# Hurricane Pavimento

## Mosaico



Mosaico assemblato su rete in fibra di vetro. Vendita solo a scatole complete / Mosaic mesh - mounted on fibreglass. To be sold as full box only / Mosaïque montée sur filet en fibre de verre. Vendable uniquement en boîtes entières / Auf Glasfasernetz geklebtes Mosaik. Abnahme nur volle Pakete.

### PEZZI SPECIALI / Special pieces / Pièces spéciales / Formteile

					
	8x80 BATTISCOPIA	7,5x60 BATTISCOPIA	33x60 GRADONE COSTA RETTA	33x30 ANGOLARE COSTA RETTA DX	SX
Pc. box	6	15	6	2	2
WHITE	0447060	0447041	0447103	0447109	0447115
CLOUD	0447101	0447142	0447104	0447110	0447116
SILVER	0447066	0447042	0447105	0447111	0447117
COAL	0447102	0447143	0447106	0447112	0447118
SMOKE	0447067	0447043	0447107	0447113	0447119
SAND	0447059	0447044	0447108	0447114	0447120

Vendita solo a scatole complete / To be sold as full box only / Vendable uniquement en boîtes entières / Abnahme nur volle Pakete.

### PEZZI SPECIALI GRIP / Grip special pieces / Pièces spéciales antidérapantes / Zubehörteile Grip

			
	33x60 GRADONE COSTA RETTA	33x30 ANGOLARE COSTA RETTA DX	SX
Pc. box	6	2	2
WHITE	0447121 GRIP	0447127 GRIP	0447133 GRIP
CLOUD	0447122 GRIP	0447128 GRIP	0447134 GRIP
SILVER	0447123 GRIP	0447129 GRIP	0447135 GRIP
COAL	0447124 GRIP	0447130 GRIP	0447136 GRIP
SMOKE	0447125 GRIP	0447131 GRIP	0447137 GRIP
SAND	0447126 GRIP	0447132 GRIP	0447138 GRIP

Vendita solo a scatole complete / To be sold as full box only / Vendable uniquement en boîtes entières / Abnahme nur volle Pakete.

### CARATTERISTICHE TECNICHE / Technical features / Caractéristiques techniques / Technische Eigenschaften



	Scivolosità: Metodo della rampa calzato \ Skid resistance: Shood Ramp Test	Scivolosità: Metodo della rampa a piedi nudi / Skid resistance: Barefoot Ramp Test	Scivolosità: Metodo del pendolo / Skid resistance: Pendolum Friction Test	Scivolosità: Coefficiente di attrito / Skid resistance: Coefficient of Friction (COF)	Scivolosità: Coefficiente di attrito dinamico / Skid resistance: Dynamic Coefficient of friction (DCOF)
R10	B	Class C2	> 0,40 Dry > 0,40 Wet	> 0,42 Wet	> 0,42 Wet
R11 GRIP	C	Class C3	> 0,40 Dry > 0,40 Wet	> 0,42 Wet	> 0,42 Wet

### IMBALLI / Packages / Emballages / Verpackungen

	SCATOLE / Boxes / Boites / Kartons			PALETTE / Pallets / Palettes / Paletten			
	pz.	mq	kg	box	mq	kg	± mm
120x120	1	1,44	38,40	36	51,84	1422,40	10,5
60x120	2	1,44	32,15	30	43,2	965	9
80x80	2	1,28	26,24	45	57,60	1189	9
40x80	4	1,28	26,24	48	61,4	1259	9
60x60	3	1,08	24	40	43,2	960	9
30x60	6	1,08	24	40	43,2	960	9
60x120 INSERTO ARKIGARDEN WHITE	2	1,44	32,15	30	43,2	965	9
30x60 MURETTO	6	1,08	22,4				9
30x30 MOSAICO	11	0,99	17				9

# Hurricane 2.0

### PEZZI SPECIALI / Special pieces / Pièces spéciales / Formteile

		
	30x120x2 GRADONE STEP	30x60x2 GRADONE STEP
Pc. Box	3	2
CLOUD	0447139	0447163
SILVER	0447069	0447164
COAL	0447140	0447165
SMOKE	0447141	0447166

Vendita solo a scatole complete / To be sold as full box only / Vendable uniquement en boîtes entières / Abnahme nur volle Pakete.

### CARATTERISTICHE TECNICHE / Technical features / Caractéristiques techniques / Technische Eigenschaften

	Scivolosità: Metodo della rampa calzato \ Skid resistance: Shood Ramp Test	Scivolosità: Metodo della rampa a piedi nudi / Skid resistance: Barefoot Ramp Test	Scivolosità: Metodo del pendolo / Skid resistance: Pendolum Friction Test	Scivolosità: Coefficiente di attrito / Skid resistance: Coefficient of Friction (COF)	Scivolosità: Coefficiente di attrito dinamico / Skid resistance: Dynamic Coefficient of friction (DCOF)
R11	C	Class C3	> 0,40 Dry > 0,40 Wet	> 0,42 Wet	> 0,42 Wet

### IMBALLI / Packages / Emballages / Verpackungen

	SCATOLE / Boxes / Boites / Kartons			PALETTE / Pallets / Palettes / Paletten			
	pz.	mq	kg	box	mq	kg	± mm
60x120	1	0,72	33,1	30	21,6	1009	20
60x60	2	0,72	33,05	32	23,04	1073	20

# Hurricane 33,3x100

## Bacchetta in alluminio

Per la posa si consigliano le normali colle in commercio, di buona qualità, per piastrelle ceramiche; togliere la carta prima del montaggio. Pulire con detergenti neutri, non abrasivi. È sconsigliata la posa a pavimento. / For laying you can use the normal adhesives for ceramic tiles on the market, of good quality; remove the paper before assembly. We recommend cleaning with neutral, non-abrasive detergents. Laying the tiles on the floor is not recommended. / Pour la pose, on peut utiliser des colles commerciales normales de bonne qualité pour les carreaux de céramique; retirer le papier avant le montage. Il est recommandé d'effectuer le nettoyage avec des détergents neutres et non abrasifs. Il n'est pas recommandé d'effectuer la pose au sol. / Für die Verlegung können handelsübliche, qualitativ hochwertige Kleber für Keramikfliesen verwendet werden; das Papier muss vor dem Verlegen entfernt werden. Eine Reinigung mit neutralen, nicht scheuernden Reinigungsmitteln wird empfohlen. Eine Bodenverlegung wird nicht empfohlen.

## Mosaico

Mosaico assemblato su rete in fibra di vetro. Vendita solo a scatole complete / Mosaic mesh - mounted on fibreglass. To be sold as full box only / Mosaïque montée sur filet en fibre de verre. Vendable uniquement en boîtes entières / Auf Glasfasernetz geklebtes Mosaik. Abnahme nur volle Pakete.

### IMBALLI / Packages / Emballages / Verpackungen

	SCATOLE / Boxes / Boites / Kartons			PALETTE / Pallets / Palettes / Paletten			
	pz.	mq	kg	box	mq	kg	± mm
33,3x100	6	2	24	48	96	1174	7
33,3x100 STRUTTURA	6	2	24	48	96	1174	7
33,3x33,3 MOSAICO BRICK	6	0,67	7,8				7
1x100 BACCHETTA	6	0,05	0,4				6

# Deco Art

Decoro con lustri/metalli preziosi utilizzabile a rivestimento. Si consiglia la pulizia con detergenti neutri, non abrasivi. Non pulire energicamente con panni o spugne. È sconsigliata la posa nell'area doccia. Si consiglia di mantenere il senso di posa indicato. / Decors with lustres/precious metals used for covering. We recommend cleaning with neutral, non-abrasive detergents. Clean gently using cloth or a sponge. Tiles should not be installed in the shower area. Compliance with the specified laying direction is strongly recommended. / Décor avec lustres/métaux précieux à poser sur le mur. Lavage recommandé avec des détergents neutres, non abrasifs. Nettoyez délicatement à l'aide d'un chiffon ou d'une éponge. Pose déconseillée dans la douche. Il est recommandé de conserver le sens de pose indiqué. Dekor mit Glanzelementen/Edelmetallen für die Wandverkleidung. Es wird die Reinigung mit neutralen, scheuermittelfreien Reinigungsmitteln empfohlen. Wischen Sie nicht Kräftig mit Tüchern oder Schwämmen. Die Verlegung in der Duschnische wird nicht empfohlen. Es wird empfohlen, die angegebene Verlegerichtung zu beachten.

### IMBALLI / Packages / Emballages / Verpackungen

	SCATOLE / Boxes / Boites / Kartons			PALETTE / Pallets / Palettes / Paletten			
	pz.	mq	kg	box	mq	kg	± mm
60x120	2	1,44	32	20	28,8	660	10

# Caratteristiche Tecniche

Technical features - Caractéristiques techniques - Technische eigenschaften

<b>GRES PORCELLANATO - UNI EN 14411 - G Bia</b> Porcelain stoneware - Grès cèrame - Feinsteinzeug	METODO DI PROVA TEST METHOD	VALORE DICHIARATO DECLARED VALUE <b>Matt</b>	VALORE DICHIARATO DECLARED VALUE <b>Grip</b>	VALORE DICHIARATO DECLARED VALUE <b>2.0</b>
Resistenza al fuoco Fire resistance	Decisione 96/603/CEE e sue modifiche	A1 <sub>fl</sub>	A1 <sub>fl</sub>	A1 <sub>fl</sub>
Assorbimento d'acqua Water absorption	EN ISO 10545-3	≤0,5%	≤0,5%	≤0,5%
Sforzo di rottura Breaking strenght	EN ISO 10545-4	S ≥ 1300 N	S ≥ 1300 N	S ≥ 1300 N
Modulo di rottura Modul of ropture		R ≥ 35 N/mm <sup>2</sup>	R ≥ 35 N/mm <sup>2</sup>	R ≥ 35 N/mm <sup>2</sup>
Resistenza all'urto Impact resistance	EN ISO 10545-5	>0,84	>0,84	>0,84
Resistenza all'abrasione profonda Abrasion resistance	EN ISO 10545-6	<175mm <sup>3</sup>	<175mm <sup>3</sup>	<175mm <sup>3</sup>
Coefficiente di dilatazione termica lineare Thermal expansion coefficient	EN ISO 10545-8	6,5x10 <sup>-6</sup> /°C	6,5x10 <sup>-6</sup> /°C	6,5x10 <sup>-6</sup> /°C
Resistenza agli sbalzi termici Resistance to thermal shocks	EN ISO 10545-9	Resiste	Resiste	Resiste
Determinazione della dilatazione dovuta all'umidità Determination of moisture expansion	EN ISO 10545-10	0,1mm/m	0,1mm/m	0,1mm/m
Resistenza al gelo Frost resistance	EN ISO 10545-12	Resiste	Resiste	Resiste
Resistenza ai prodotti chimici di uso domestico e agli additivi per piscina Resistance to household chemicals and swimming pool salts	EN ISO 10545-13	A	A	A
Resistenza a basse concentrazioni di acidi e alcali Resistance to low concentration of acids and alkalis		LA	LA	LA
Resistenza ad alte concentrazioni di acidi e alcali Resistance to high concentration of acids and alkalis		HA	HA	HA
Resistenza alle macchie Resistance to stains	EN ISO 10545-14	5	5	5
Scivolosità: Metodo della rampa calzato Skid resistance: Shood Ramp Test	DIN 51130	R 10	R 11	R11
Scivolosità: Metodo della rampa a piedi nudi Skid resistance: Barefoot Ramp Test	DIN 51097	B	C	C
	BS 7976	≥ 36 Dry ≥ 36 Wet	≥ 36 Dry ≥ 36 Wet	≥ 36 Dry ≥ 36 Wet
	AS 4586	Class P3	Class P4	Class P4
Scivolosità: Metodo del pendolo Skid resistance: Pendolum Friction Test	UNE-ENV 12633	Class C2	Class C3	Class C3
	B.C.R.A. Rep. CEC/81	>0,40 Dry >0,40 Wet	>0,40 Dry >0,40 Wet	>0,40 Dry >0,40 Wet
Scivolosità: Coefficiente di attrito Skid resistance: Coefficient of Friction (COF)	B.C.R.A. Rep. CEC/81	>0,40 Dry >0,40 Wet	>0,40 Dry >0,40 Wet	>0,40 Dry >0,40 Wet
Scivolosità: Coefficiente di attrito dinamico Skid resistance: Dynamic Coefficient of friction (DCOF)	ANSI DCOF A137.1-2012	>0,42 Wet	>0,42 Wet	>0,42 Wet

<b>BICOTTURA - UNI EN 14411 - BIII</b> Double firing - Bicuison - Zweibrandfliesen	METODO DI PROVA TEST METHOD	VALORE DICHIARATO DECLARED VALUE
Assorbimento d'acqua Water absorption	EN ISO 10545-3	>10%
Sforzo di rottura Breaking strenght	EN ISO 10545-4	S ≥ 600 N
Resistenza alla flessione Bending strenght		R ≥ 12 N/mm <sup>2</sup>
Resistenza agli sbalzi termici Resistance to thermal shocks	EN ISO 10545-9	Conforme
Resistenza al cavillo Crazing resistance	EN ISO 10545-11	Resiste
Resistenza ai prodotti chimici di uso domestico e agli additivi per piscina Resistance to household chemicals and swimming pool salts	EN ISO 10545-13	Resiste
Resistenza a basse concentrazioni di acidi e alcali Resistance to low concentration of acids and alkalis		Resiste
Resistenza alle macchie Resistance to stains	EN ISO 10545-14	Classe 5

# ARMONIE

Via Statale 467 - n.136  
42013 Casalgrande - Reggio Emilia - Italy  
T +39 0536 823 203 - 0536 802 214  
F +39 0536 822 812 - 0536 889 511  
[www.armonieceramiche.com](http://www.armonieceramiche.com)  
[info@armonieceramiche.com](mailto:info@armonieceramiche.com)