



Evoluta

5 COLOURS

3 SIZES

3 SURFACES

Evoluta is the latest, most modern porcelain stoneware generation: thanks to a **ground-breaking technology** exclusively developed in the Piemme plants, it offers surfaces with a naturalness and variety of colour never previously achieved.

CERAMICHE **PIEMME**

FLOOR AND MORE

Evoluta rappresenta l'ultima e più moderna generazione del gres porcellanato; grazie ad una **tecnologia innovativa**, sviluppata in esclusiva negli stabilimenti Piemme, è in grado di esprimere naturalezza di superficie e varietà cromatiche mai viste fino ad oggi.

Evoluta gehört zur jüngsten Feinsteinzeuggeneration. Dank einer **innovativen Verfahrenstechnik**, exklusiv entwickelt an den Produktionsstandorten von Piemme, besticht Evoluta mit naturnaher Optik und ungewohnten, aufregenden Farbstellungen.

Evoluta représente la dernière et plus moderne génération de grès cérame. **Une technologie révolutionnaire**, mise au point en exclusivité dans les usines Piemme, permet désormais d'aboutir à un naturel et à un panaché de couleurs encore jamais vus jusqu'à présent.

Evoluta



Una Tecnologia Rivoluzionaria
A Revolutionary Technology

P. 5

Spazi Pubblici
Public Areas

P. 13

Spazi Residenziali
Residential Spaces

P.37

Informazioni Tecniche
Technical Information

P. 61

E' ispirata alle rocce metamorfiche, come la quarzite tipica delle Alpi centrali italiane, ed è rielaborata in sfumature contemporanee create per rivestire tutti gli spazi che, prendendo spunto dai concetti chiave dell'architettura organica, vogliono esprimere un forte legame con la natura e con le sue bellezze. **Con una casualità di varianti grafiche e di strutture pressochè illimitata**, Evoluta è una collezione cosmopolita, ideale per pavimenti e rivestimenti di ambienti residenziali e commerciali.

It is inspired by metamorphic rocks such as the quartzite found in the central Italian Alps, reinterpreted in contemporary colour shades for the decoration of all spaces that embrace the key concepts of organic architecture and aim to express a strong bond with nature and its many beauties.

With a virtually unlimited random assortment of patterning and structural variations, Evoluta is a cosmopolitan collection, ideal for the floors and walls of residential and commercial locations.

Sie ist von metamorphischen Gesteinen wie dem Quarzit aus den italienischen Zentralalpen inspiriert und kommt in zeitgemäßen, raumübergreifenden Nuancen daher, die an die Schlüsselkonzepte der organischen Architektur anknüpfen und eine enge Beziehung zur Natur zum Ausdruck bringen.

Mit einer nahezu unbegrenzten gestalterischen und strukturellen Mannigfaltigkeit erweist sich Evoluta als ausnehmend kosmopolitische Kollektion, die ideal für Boden- und Wandbeläge im privaten und gewerblichen Bereich ist.

Inspirée des roches métamorphiques, comme le quartzite typique des Alpes centrales italiennes, elle est retravaillée avec des nuances contemporaines s'accordant à tous les cadres qui, selon les concepts clés de l'architecture organique, veulent exprimer un lien étroit avec la nature et avec toutes ses beautés.

Forte d'un nombre pratiquement illimité de variantes graphiques et structurelles aléatoires, la collection Evoluta est cosmopolite, parfaite sur les sols et murs résidentiels et commerciaux.

Synchro Digit Piemme

Una Tecnologia Rivoluzionaria

A Revolutionary Technology
Eine revolutionäre Technologie
Une Technologie Révolutionnaire



PAGINA / PAGE

Synchronized Digital Structured Surface	6
Unlimited Graphic Variants	8
New Material Realism	10
Evoluta A Revolutionary Technology	5

Superficie con Struttura Digitale Sincronizzata / Synchro Digit Piemme

Evoluta marks the launch of “Synchro Digit”: the Piemme synchronized digital structure surface capable of expressing itself in unlimited variants that raise the quality standard of the entire ceramic industry. The three-dimensional surface is no longer formed by pressing and is therefore not limited by the repetitive constraints of classic ceramic moulds; it is also perfectly synchronized with the surface graphic pattern.

In Evoluta zeigt sich zum ersten Mal „Synchro Digit“, die mit synchronisierter digitalen Struktur Oberfläche Piemme, die durch die Eröffnung unbegrenzter Gestaltungsvarianten den Qualitätsstandard der gesamten Keramikbranche anhebt. Die reliefierte Oberfläche wird nicht mehr durch Pressung erzielt und ist deshalb auch nicht an die Wiederholungsmuster der klassischen Formpressen für Keramik gebunden. Sie ist auch mit den Oberflächengrafiken vollkommen synchronisiert.

Evoluta marque la naissance de « Synchro Digit », la surface avec structure synchronisée numérique Piemme, dont les variantes illimitées permettent une expression qui vient rehausser les normes de qualité de tout le secteur de la céramique. La surface tridimensionnelle n'étant plus formée par pressage, elle est désormais libérée des contraintes répétitives imposées par les moules pour céramique classiques. Par ailleurs, elle est parfaitement synchronisée avec l'évolution des éléments graphiques de la surface.

**Nasce con Evoluta “Synchro Digit”:
la Superficie con Struttura Digitale
Sincronizzata Piemme capace di
esprimersi in varianti illimitate che
innalzano lo standard qualitativo
dell'intero settore ceramico.
La superficie tridimensionale non
è più formata per pressatura ed è
quindi libera dai vincoli ripetitivi dei
classici stampi per ceramica; inoltre
è perfettamente sincronizzata con
l'andamento della grafica di superficie.**



Naked Synchro Digit Structure

Varianti Grafiche Illimitate / Unlimited Graphic Variants

The patient study of the finest features of natural stone by Piemme's technical staff has enabled the perfection of every single aesthetic detail, resulting in varied subjects that currently include over three hundred different patterns with 300 DPI.

Die Experten der Designabteilung von Piemme setzten sich eingehend mit den feinsten Merkmalen des Originalgesteins auseinander und konnten selbst kleinste optische Details gestalten. So entstand ein abwechslungsreiches Design, das in mehr als dreihundert verschiedenen Varianten mit 300 dpi daherkommt.

S'appuyant sur une étude approfondie des caractéristiques les plus fines de la pierre d'origine, les techniciens de Piemme ont mis au point le moindre détail esthétique, aboutissant ainsi à la création d'une infinité de sujets : aujourd'hui, la gamme compte plus de trois cents éléments graphiques différents d'une résolution de 300 dpi.

60x119,5 - 24"x47½" Cosmopolitan Lappato Rettificato

L'attento studio da parte dei tecnici Piemme delle più fini peculiarità della pietra originaria, ha reso possibile la messa a punto di ogni singolo dettaglio estetico, ottenendo una variabilità di soggetti che oggi raggiunge e supera le trecento differenti grafiche di produzione a 300 dpi.



Nuovo Realismo Materico / New Material Realism

Thanks to the synchronization of the "Piemme Digital Structure" with the infinite production patterns, the Evoluta surface details are as three-dimensional and variable in depth as those of natural stone itself. The new "Synchro Digit Piemme" enables a level of material realism that is virtually indistinguishable from the surface of the original stone.

Durch die Synchronisierung der „Digitale Struktur von Piemme“ und die zahlreichen Designvarianten erreichen die Details der Oberfläche von Evoluta eine Plastizität und Unebenheit, die mit dem Naturstein vergleichbar sind. Die neue „Synchro Digit von Piemme“ ermöglicht ein äußerst realistisches Materialbild, das sich kaum nicht von der Gesteinsvorlage unterscheidet.

Grâce à la synchronisation de la « Structure numérique Piemme » et à l'infinité des éléments graphiques de production, le détail de la surface d'Evoluta présente des niveaux de tridimensionnalité et de variabilité d'épaisseur comparables à ceux de la pierre naturelle. La nouvelle technologie « Syncro Digit » permet d'obtenir un effet matière dont le réalisme est tellement abouti qu'on ne peut quasiment distinguer la différence avec la surface de la pierre d'origine.

Grazie alla sincronizzazione della “Struttura Digitale Piemme” con le infinite grafiche di produzione, il dettaglio della superficie di Evoluta raggiunge livelli di tridimensionalità e di variabilità di spessore paragonabili a quelli della pietra naturale. La nuova Synchro Digit Piemme rende possibile un realismo materico praticamente indistinguibile rispetto alla superficie di origine lapidea.

60×119,5 - 24"×47½" Cosmopolitan Lappato Rettificato



Evoluta
A Revolutionary Technology

Spazi Pubblici

Public Areas
 Öffentliche Räumlichkeiten
 Espaces Publics



COLORI / COLOURS

AMBIENTI / AMBIENT

PAGINA / PAGE

Cosmopolitan / Forest	Lounge	14
Forest / Global	Bathroom	18
Cave Light / Modern	Spa	24
Advanced / Global / Cluster Dark	Food Court	28
Beyond / Cluster Multicolor	Restaurant	32



Forest

Latest-generation digital technology and delicate honing make it possible to create infinitely variable three-dimensional coverings such as "Forest", which thanks to its modularity does not have to be laid in a particular manner or order, ideal for enhancing the small and large walls of public and residential locations.

Die digitale Technologie der neuesten Generation und die sanfte Läppung ermöglichen die Schaffung von Wandverkleidungen in Reliefoptik mit sehr abwechslungsreichen Optiken wie „Forest“. Diese Fliesen, die dank ihrer Modularität kein bestimmtes Verlegemuster vorschreiben, sind perfekt zur wertigen Gestaltung von kleinen und großen Wänden in öffentlichen und privaten Bereichen.

La technologie numérique de dernière génération et le délicat effet lappato permettent de créer des revêtements tridimensionnels présentant une variabilité illimitée, comme « Forest » qui, en raison de sa modularité, s'affranchit de toute obligation de pose ou de tout schéma, parfait pour valoriser les murs, petits et grands, des lieux publics et résidentiels.

60×119,5 - 24"×47½" Forest Lappato Rettificato

La tecnologia digitale di ultima generazione e la delicata lappatura consentono di creare rivestimenti tridimensionali dalla variabilità infinita come "Forest", che grazie alla sua modularità è libera da vincoli di posa e di schemi da seguire, ideale per valorizzare piccole e grandi pareti di ambienti pubblici e residenziali.

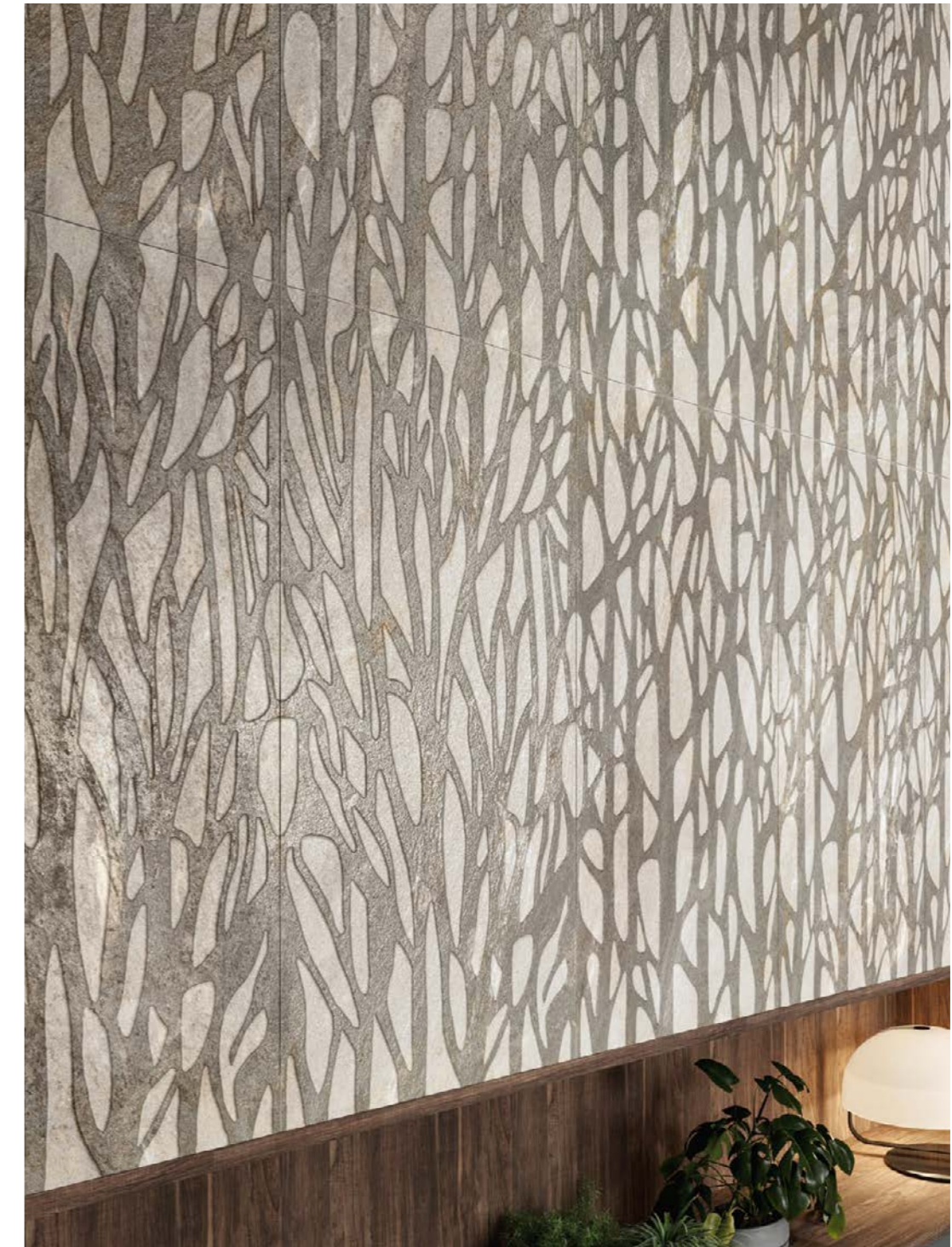



Global

The slightly irregular surface, combined with limitless streaks of colour, offer an effortless rendering of the aesthetics of stone, contributing to the creation of environments with a warm, natural atmosphere.

Mit ihrer leicht unregelmäßigen Oberfläche und den zahlreichen Farbsprenkeln spielen sie mit Nonchalance an eine Steinoptik an und tragen zur Schaffung natürlich warmer Raumatmosphären bei.

Légèrement irrégulière, la surface présente aussi d'innombrables bigarrures de couleur qui, avec grande désinvolture, lui donnent un aspect similaire à celui de la pierre, de sorte à composer des ambiances chaleureuses et naturelles.

La superficie lievemente irregolare, unita alle infinite screziature di colore, si avvicinano con grande disinvoltura all'estetica della pietra, contribuendo alla creazione di ambienti dall'atmosfera di calda naturalezza.

60x119,5 - 24"x47½" Global Naturale Rettificato



Evoluta
Public Areas

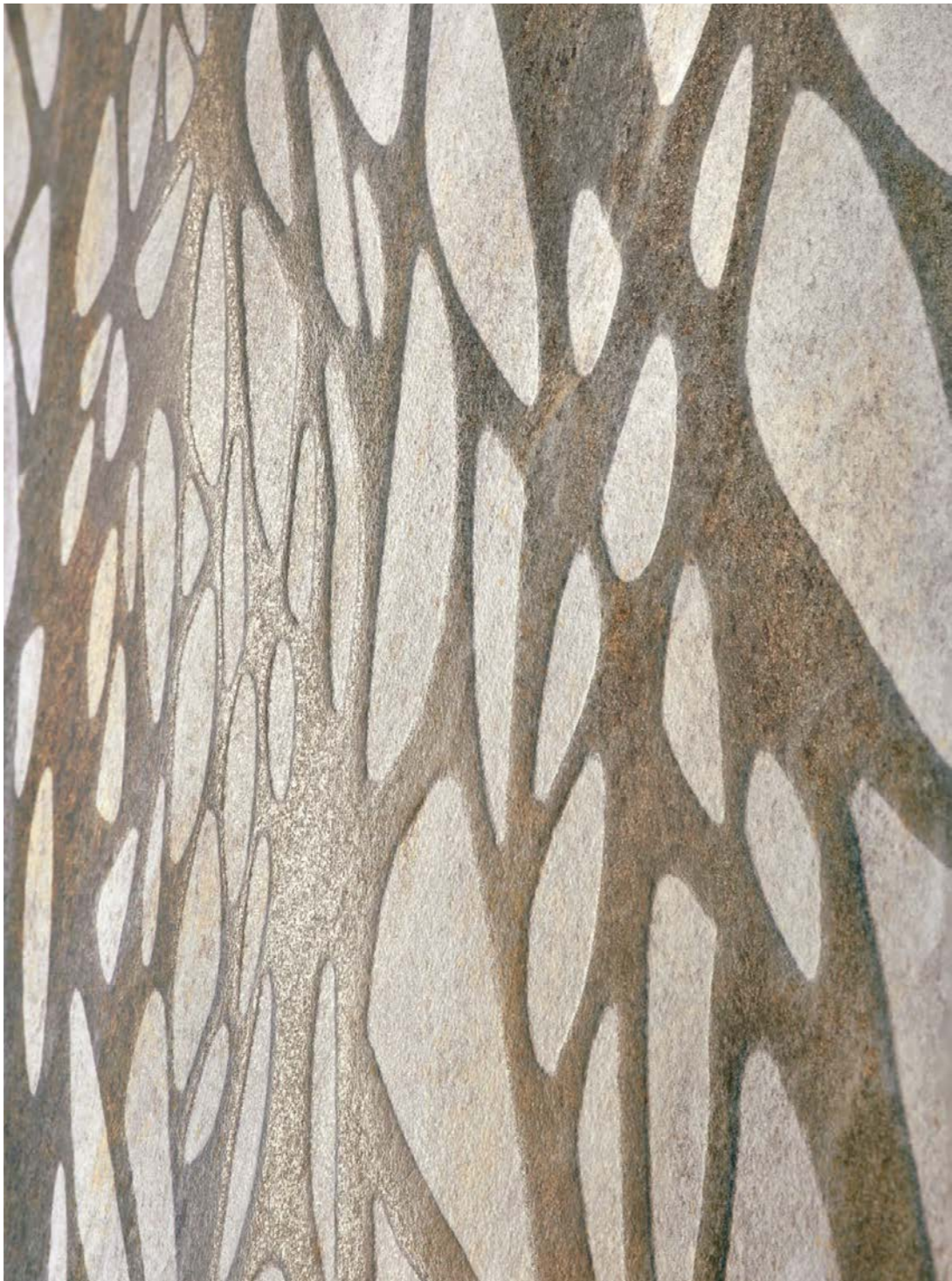



Forest Light / Modern

60x119,5 - 24"x47½" Forest Light Lappato Rettificato
60x60 - 24"x24" Modern Naturale Rettificato



60x60 - 24"x24" Modern Naturale Rettificato





Cluster Dark

Featuring virtually unlimited patterning and structural variations for every single hexagon, "Cluster" is a cosmopolitan decor that is easy to combine and ideal for the floors and walls of residential and public locations.

Bei „Cluster“ ist jedes einzelne Sechseck in Dessin und Oberflächenstruktur sehr abwechslungsreich gestaltet. Es ist ein kosmopolitisches Dekor, das sich gut kombinieren lässt und für Boden- und Wandbeläge in privaten und öffentlichen Bereichen geeignet ist.

Grace à une variabilité graphique et structurelle pratiquement illimitée sur chaque hexagone, le décor cosmopolite « Cluster » est facile à assortir, idéal sur les sols et murs résidentiels et publics.

Con una variabilità grafica e di struttura pressoché illimitata per ogni singolo esagono, "Cluster" è un decoro cosmopolita dalla grande abbinabilità, ideale per pavimenti e rivestimenti di ambienti residenziali e pubblici.

60×119,5 - 24"×47½" Cluster Dark Naturale Rettificato







Spazi Residenziali

Residential Spaces
Wohnanlagen
Espaces Résidentiels



COLORI / COLOURS

AMBIENTI / AMBIENT

PAGINA / PAGE

Global / Cave Dark	Living	39
Global / Advanced	Outdoor	43
Beyond / Cluster Light	Kitchen	46
Global / Advanced / Cave Multicolor	Bathroom	50
Cosmopolitan / Cave Multicolor	Bedroom	54
Cluster Light / Modern	Bathroom	56

Global / Cave Dark

The unusual honing increases the material's depth and shine, and helps to give surfaces an almost magnetic allure, enabling architects and interior designers to make almost any location absolutely unique.

Der besondere Läppvorgang verstärkt die plastische Tiefenwirkung und den Glanz der Oberflächen und ermöglicht dem Planer die Gestaltung von Flächenbildern mit einer magnetischen Ausstrahlung, die jedes Ambiente zu einem einzigartigen Design-Highlight machen.

L'effet lappato exalte la profondeur et l'éclat de la matière, et il apporte à la surface un charme presque magnétique en aidant le designer à faire de chaque projet un élément unique et sans égal.

La particolare lappatura apporta ulteriore profondità e lucentezza alla materia e contribuisce a conferire alle superfici un fascino quasi magnetico, aiutando il progettista a rendere qualsiasi ambiente unico ed irripetibile.

60×119,5 - 24"×47½" Global Lappato Rettificato

30×60 - 12"×24" Cave Dark Naturale Rettificato



Cave Dark / Global

The Cave three-dimensional wall tiles are a detailed evocation of the master-craftsmanship involved in cutting and recomposing small blocks of stone to create decorative walls with a warm, natural air.

Die Reliefoptik der Wandverkleidung Cave greift bis ins Detail handwerklich bearbeitete und zusammengesetzte Steinriemchen auf, die reizvolle Dekorwände in einer natürlichen, wohnlichen Optik entstehen lassen.

Les revêtements muraux tridimensionnels « Cave » reprennent en détail l'art extraordinaire de la découpe et de la recomposition de petits morceaux de pierre pour créer des murs ornementaux, avec des traits chauds et naturels.

Le superfici tridimensionali per rivestimento “Cave” riprendono in dettaglio la sapiente maestria del taglio e ricomposizione dei piccoli tasselli in pietra per creare pareti decorative dai tratti caldi e naturali.

30×60 - 12”×24” Cave Dark Naturale Rettificato

60×119,5 - 24”×47½” Global Lappato Rettificato



Evoluta
Residential Spaces

Inspired by quartzite from a depleted quarry in the Italian Alps, Evoluta is reinterpreted in contemporary colour shades created to decorate all spaces that express a strong bond with nature and its abundant beauty.

Vom Quarzit eines alten Steinbruchs der italienischen Alpen inspiriert kommt Evoluta in zeitgemäßen, raumübergreifenden Nuancen daher, die eine enge Beziehung zur Natur und ihren Schönheiten zum Ausdruck bringen wollen.

Inspirée de la quartzite d'une carrière épuisée dans les Alpes italiennes, la collection Evoluta est retravaillée avec des nuances contemporaines pour s'accorder à tous les cadres qui veulent exprimer un lien étroit avec la nature et toutes ses beautés.

Ispirata alla quarzite di una cava esaurita delle Alpi italiane, Evoluta è rielaborata in sfumature contemporanee create per rivestire tutti gli spazi che vogliono esprimere un forte legame con la natura e le sue bellezze.







Beyond

Evoluta's balanced rhapsody of colours, combined with the infinite vein patterns and deposits typical of the natural stones that inspire it, create an overall sense of harmony with immense aesthetic value.

Das breit gefächerte Farbspektrum von Evoluta ermöglicht – gepaart mit den charakteristischen vielgestaltigen Äderungen und Einlagerungen der Natursteine, von denen die Kollektion inspiriert ist – stimmige Gestaltungslösungen mit einer wertigen Ästhetik.

L'harmonieuse rhapsodie d'Evoluta au niveau des couleurs, ainsi que ses innombrables veines et concrétions, typiques des pierres naturelles d'inspiration, forment un équilibre d'ensemble à haute valeur esthétique.

La bilanciata rapsodia cromatica di Evoluta, unita alle infinite venature e concrezioni, tipiche delle pietre naturali a cui si ispira, creano un equilibrio d'insieme di grande valenza estetica.

30x60 - 12"x24" Beyond Naturale Rettificato



Evoluta
Residential Spaces











Informazioni Tecniche

5

Colori
Colours
Farben
Couleurs

Modern



Beyond



Global

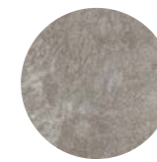

Advanced

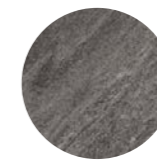

Cosmopolitan

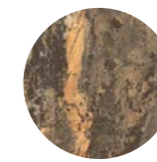

3

Formati
Sizes
Formate
Formats

*60×119,5
24"×47½"



60×60
24"×24"



30×60
12"×24"



*formato modulare con 60x60 e 30x60 / modular size, can be matched with 60x60 and 30x60 size /
modulares, sprich mit dem Format 60x60 und 30x60 kombinierbares Format / format modulaire pouvant être coordonné au format 60x60 et 30x60

1

Spessori
Thickness
Stärke
Epaisseur

±9,5

3

Superfici
Surfaces
Oberflächen
Surfaces

Naturale

Lappato

Grip

3

Strutture 3D
3D structures
Strukturen
Décorations en relief

Cave



Cluster



Forest



i



Tecnologia - Technology - Technologie:
Synchro Digit Piemme

Superficie con struttura digitale sincronizzata
Synchronized digital structured surface

Im synchronisierten Digitaldruckverfahren
hergestellte 3D-Oberfläche

Surface avec texture et finition par
impression numérique synchronisée

Gres fine porcellanato ad impasto colorato
Coloured-body fine porcelain stoneware
Feinsteinzeug aus farbiger Masse
Grès cérame fin à pâte colorée

Effetto Pietra
Stone Look
Natursteinoptik
Effet Pierre

Rivestimento
Wall Tiles
Wandfliesen
Revêtement

Pavimento
Floor Tiles
Bodenfliesen
Sol



Gres fine porcellanato ad impasto colorato
Tecnologia Synchro Digit Piemme

Coloured-body fine porcelain stoneware
Synchro Digit Piemme Technology

Feinsteinzeug aus farbiger Masse
Synchro Digit Piemme Technologie

Grès cérame fin à pâte colorée
Technologie Synchro Digit Piemme

Modern

Per un risultato di posa ottimale si consiglia di prelevare le piastrelle da 5/6 scatole contemporaneamente.

For best installation results, we suggest taking the tiles from 5/6 boxes at the same time.



± 9,5

*60x119,5 - 24"x47¼"

03544 | Evoluta Modern Nat/Ret
03548 | Evoluta Modern Lap/Ret
03552 | Evoluta Modern Grip/Ret



± 9,5

60x60 - 24"x24"

03536 | Evoluta Modern Nat/Ret
03540 | Evoluta Modern Lap/Ret



± 9,5

30x60 - 12"x24"

03528 | Evoluta Modern Nat/Ret
03532 | Evoluta Modern Lap/Ret



*60x119,5 - 24"x47¼"

03614 | Evoluta Cluster Light Nat/Ret



30x60 - 12"x24"

03609 | Evoluta Cave Light Nat/Ret



*60x119,5 - 24"x47¼"

03685 | Evoluta Forest Light Lap/Ret

* formato modulare con 60x60 e 30x60 / modular size, can be matched with 60x60 and 30x60 size /
modulares, sprich mit dem Format 60x60 und 30x60 kombinierbares Format / format modulaire pouvant être coordonné au format 60x60 et 30x60

Pezzi speciali
Special pieces

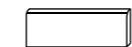

Battiscopa 4,5x60 ± 9,5

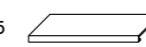

Gradino Costa Retta 33x119,5 ± 9,5

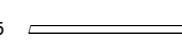

Bacchetta Jolly 1,5x119,5 ± 9,5

Unghia Jolly 1,5x1,5 ± 9,5



Gres fine porcellanato ad impasto colorato
Tecnologia Synchro Digit Piemme

Coloured-body fine porcelain stoneware
Synchro Digit Piemme Technology

Feinsteinzeug aus farbiger Masse
Synchro Digit Piemme Technologie

Grès cérame fin à pâte colorée
Technologie Synchro Digit Piemme

Beyond

Per un risultato di posa ottimale si consiglia di prelevare le piastrelle da 5/6 scatole contemporaneamente.

For best installation results, we suggest taking the tiles from 5/6 boxes at the same time.



± 9,5

*60x119,5 - 24"x47¼"

03596 | Evoluta Beyond Nat/Ret
03597 | Evoluta Beyond Lap/Ret
03598 | Evoluta Beyond Grip/Ret



± 9,5

60x60 - 24"x24"

03594 | Evoluta Beyond Nat/Ret
03595 | Evoluta Beyond Lap/Ret



± 9,5

30x60 - 12"x24"

03592 | Evoluta Beyond Nat/Ret
03593 | Evoluta Beyond Lap/Ret



*60x119,5 - 24"x47¼"

03614 | Evoluta Cluster Light Nat/Ret



30x60 - 12"x24"

03609 | Evoluta Cave Light Nat/Ret



*60x119,5 - 24"x47¼"

03685 | Evoluta Forest Light Lap/Ret

* formato modulare con 60x60 e 30x60 / modular size, can be matched with 60x60 and 30x60 size /
modulares, sprich mit dem Format 60x60 und 30x60 kombinierbares Format / format modulaire pouvant être coordonné au format 60x60 et 30x60

Pezzi speciali
Special pieces

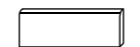

Battiscopa 4,5x60 ± 9,5

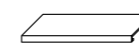

Gradino Costa Retta 33x119,5 ± 9,5

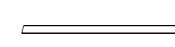

Bacchetta Jolly 1,5x119,5 ± 9,5

Unghia Jolly 1,5x1,5 ± 9,5



Gres fine porcellanato ad impasto colorato
Tecnologia Synchro Digit Piemme

Coloured-body fine porcelain stoneware
Synchro Digit Piemme Technology

Feinsteinzeug aus farbiger Masse
Synchro Digit Piemme Technologie

Grès cérame fin à pâte colorée
Technologie Synchro Digit Piemme

Global

Per un risultato di posa ottimale si consiglia di prelevare le piastrelle da 5/6 scatole contemporaneamente.

For best installation results, we suggest taking the tiles from 5/6 boxes at the same time.



± 9,5

*60x119,5 - 24"x47¼"

03545 | Evoluta Global Nat/Ret
03549 | Evoluta Global Lap/Ret
03553 | Evoluta Global Grip/Ret



± 9,5

60x60 - 24"x24"

03537 | Evoluta Global Nat/Ret
03541 | Evoluta Global Lap/Ret



± 9,5

30x60 - 12"x24"

03529 | Evoluta Global Nat/Ret
03533 | Evoluta Global Lap/Ret



*60x119,5 - 24"x47¼"

03613 | Evoluta Cluster Dark Nat/Ret



30x60 - 12"x24"



03608 | Evoluta Cave Dark Nat/Ret



*60x119,5 - 24"x47¼"

03612 | Evoluta Forest Lap/Ret

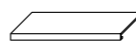
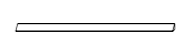
* formato modulare con 60x60 e 30x60 / modular size, can be matched with 60x60 and 30x60 size /
modulares, sprich mit dem Format 60x60 und 30x60 kombinierbares Format / format modulaire pouvant être coordonné au format 60x60 et 30x60

Pezzi speciali Special pieces  Battiscopa 4,5x60 ± 9,5  Gradino Costa Retta 33x119,5 ± 9,5  Bacchetta Jolly 1,5x119,5 ± 9,5  Unghia Jolly 1,5x1,5 ± 9,5

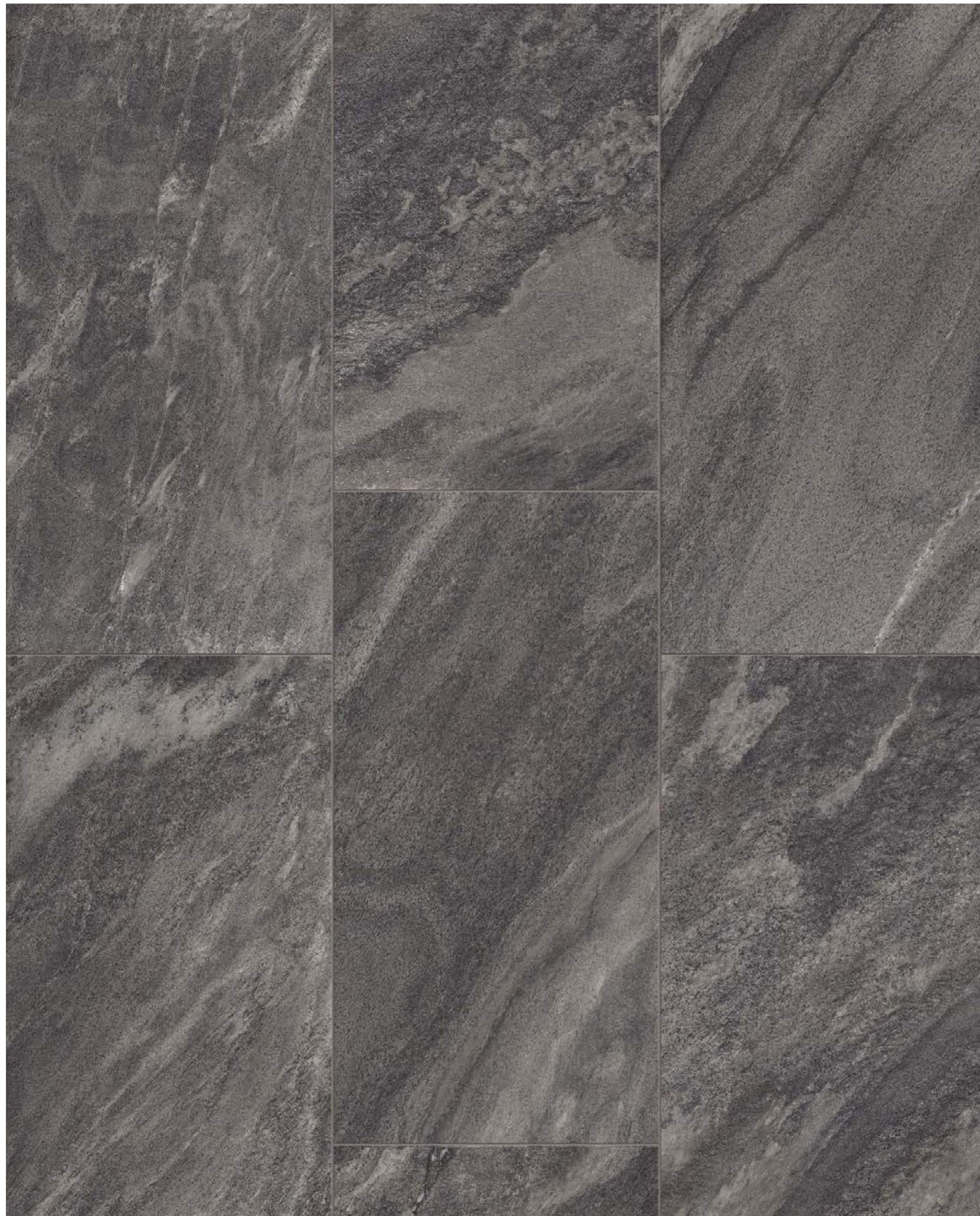

Gres fine porcellanato ad impasto colorato
Tecnologia Synchro Digit Piemme

Coloured-body fine porcelain stoneware
Synchro Digit Piemme Technology

Feinsteinzeug aus farbiger Masse
Synchro Digit Piemme Technologie

Grès cérame fin à pâte colorée
Technologie Synchro Digit Piemme

Advanced

Per un risultato di posa ottimale si consiglia di prelevare le piastrelle da 5/6 scatole contemporaneamente.

For best installation results, we suggest taking the tiles from 5/6 boxes at the same time.



± 9,5

*60×119,5 - 24"×47¼"

03543 | Evoluta Advanced Nat/Ret
03547 | Evoluta Advanced Lap/Ret
03551 | Evoluta Advanced Grip/Ret

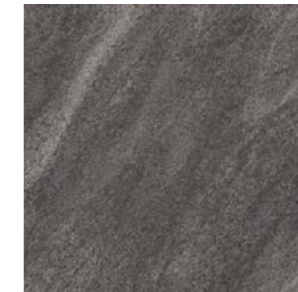

± 9,5

60×60 - 24"×24"

03535 | Evoluta Advanced Nat/Ret
03539 | Evoluta Advanced Lap/Ret

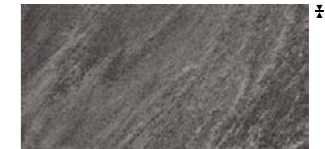

± 9,5

30×60 - 12"×24"

03527 | Evoluta Advanced Nat/Ret
03531 | Evoluta Advanced Lap/Ret



*60×119,5 - 24"×47¼"

03613 | Evoluta Cluster Dark Nat/Ret



30×60 - 12"×24"



03608 | Evoluta Cave Dark Nat/Ret



*60×119,5 - 24"×47¼"

03612 | Evoluta Forest Lap/Ret

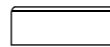
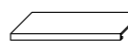
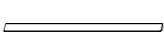
* formato modulare con 60x60 e 30x60 / modular size, can be matched with 60x60 and 30x60 size /
modulares, sprich mit dem Format 60x60 und 30x60 kombinierbares Format / format modulaire pouvant être coordonné au format 60x60 et 30x60

Pezzi speciali Special pieces  Battiscopa 4,5×60 ± 9,5  Gradino Costa Retta 33×119,5 ± 9,5  Bacchetta Jolly 1,5×119,5 ± 9,5  Unghia Jolly 1,5×1,5 ± 9,5

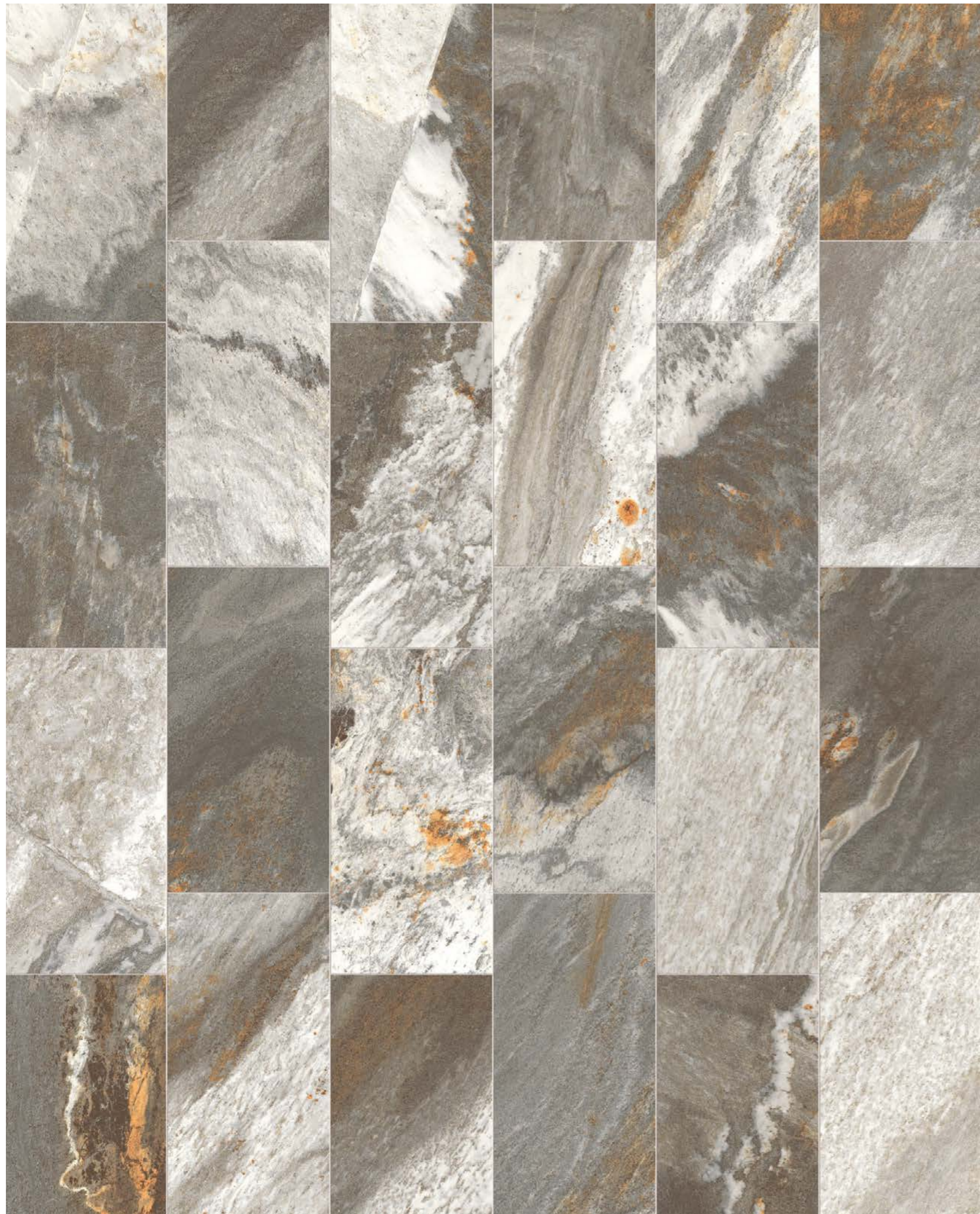

Gres fine porcellanato ad impasto colorato
Tecnologia Synchro Digit Piemme

Coloured-body fine porcelain stoneware
Synchro Digit Piemme Technology

Feinsteinzeug aus farbiger Masse
Synchro Digit Piemme Technologie

Grès cérame fin à pâte colorée
Technologie Synchro Digit Piemme

Cosmopolitan

Per un risultato di posa ottimale si consiglia di prelevare le piastrelle da 5/6 scatole contemporaneamente.

For best installation results, we suggest taking the tiles from 5/6 boxes at the same time.



± 9,5

*60x119,5 - 24"x47¼"

03546 | Evoluta Cosmopolitan Nat/Ret
03550 | Evoluta Cosmopolitan Lap/Ret
03554 | Evoluta Cosmopolitan Grip/Ret

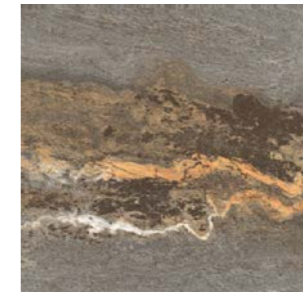

± 9,5

60x60 - 24"x24"

03538 | Evoluta Cosmopolitan Nat/Ret
03542 | Evoluta Cosmopolitan Lap/Ret



± 9,5

30x60 - 12"x24"

03530 | Evoluta Cosmopolitan Nat/Ret
03534 | Evoluta Cosmopolitan Lap/Ret



*60x119,5 - 24"x47¼"

03615 | Evoluta Cluster Multicolor Nat/Ret



30x60 - 12"x24"

03611 | Evoluta Cave Multicolor Nat/Ret



*60x119,5 - 24"x47¼"

03612 | Evoluta Forest Lap/Ret

* formato modulare con 60x60 e 30x60 / modular size, can be matched with 60x60 and 30x60 size /
modulares, sprich mit dem Format 60x60 und 30x60 kombinierbares Format / format modulaire pouvant être coordonné au format 60x60 et 30x60

Pezzi speciali Special pieces  Battiscopa 4,5x60 ± 9,5  Gradino Costa Retta 33x119,5 ± 9,5  Bacchetta Jolly 1,5x119,5 ± 9,5  Unghia Jolly 1,5x1,5 ± 9,5

Cosmopolitan 60x119,5 / 80 Patterns and Structures



Riepilogo Gamma

Collection
Serie
Gamme

Formati Sizes	60*119,5 24"*47½"	60*60 24"*24"	30*60 12"*24"	DIN 51130	DIN 51097	DCOF	BS EN 7976-2	Strutture 3D 3D Structures				Pezzi Speciali Special Pieces					
								Cluster 60*119,5 24"*47½"	Forest Light 60*119,5 24"*47½"	Forest 60*119,5 24"*47½"	Cave 30*60 12"*24"	Gradino Costa Retta 33*119,5 13"*47½"	Battiscopa 4,5*60 1½"*24"	Bacchetta Jolly 1,5*119,5 ½"*47½"	Unghia Jolly 1,5*1,5 ½"*½"		
	± 9,5	± 9,5	± 9,5					± 9,5	± 9,5	± 9,5	± 9,5	± 9,5	± 9,5	± 9,5	± 9,5	± 9,5	
Modern	Nat/Ret	03544	03536	03528	R10	A+B	>0.42	P3	03614				03609	03564	03556	03572	03581
	Lap/Ret	03548	03540	03532	V3		0.42			03685				03568	03560	03576	03585
	Grip/Ret	03552			R11	A+B+C	>0.42	P4									
Beyond	Nat/Ret	03596	03594	03592	R10	A+B	>0.42	P3	03614				03609	03602	03599	03604	03606
	Lap/Ret	03597	03595	03593	V3		0.42			03685				03603	03601	03605	03607
	Grip/Ret	03598			R11	A+B+C	>0.42	P4									
Global	Nat/Ret	03545	03537	03529	R10	A+B	>0.42	P3	03613				03608	03565	03557	03573	03582
	Lap/Ret	03549	03541	03533	V3		0.42				03612			03569	03561	03577	03586
	Grip/Ret	03553			R11	A+B+C	>0.42	P4									
Advanced	Nat/Ret	03543	03535	03527	R10	A+B	>0.42	P3	03613				03608	03563	03555	03571	03579
	Lap/Ret	03547	03539	03531	V3		0.42				03612			03567	03559	03575	03584
	Grip/Ret	03551			R11	A+B+C	>0.42	P4									
Cosmopolitan	Nat/Ret	03546	03538	03530	R10	A+B	>0.42	P3	03615				03611	03566	03558	03574	03583
	Lap/Ret	03550	03542	03534	V4		0.42				03612			03570	03562	03578	03587
	Grip/Ret	03554			R11	A+B+C	>0.42	P4									

Imballi

Packing
Verpackung
Emballage

Formati Sizes	± MM	Pezzi Scatola Pieces/Box Stck/Karton Carreaux/Boîte	Mq/Scatola Sqmt/Box Qm/Karton M2/Boîte	Kg/Scatola Kgs/Box Kg/Karton Kg/Boîte	Scatole/Paletta Boxes/Pallet Karton/Palette Boîte/Palette	Mq/Paletta Sqmt/Pallet Qm/Pallet M2/Palette	Kg/Paletta Kgs/Pallet Kg/Pallet Kg/Palette	Formato Paletta Size Pallet Format Pallet Dim. Palette	
60*119,5 (24"*47½") Nat/Ret	P	9,5	2	1,434	31,00	30	43,02	930	120x80x75
60*119,5 (24"*47½") Lap/Ret	P	9,5	2	1,434	31,00	30	43,02	930	120x80x75
60*119,5 (24"*47½") Grip/Ret	P	9,5	2	1,434	31,00	30	43,02	930	120x80x75
60*60 (24"*24") Nat/Ret	P	9,5	3	1,08	21,50	40	43,2	860	120x80x75
60*60 (24"*24") Lap/Ret	P	9,5	3	1,08	22,50	40	43,2	900	120x80x75
30*60 (12"*24") Nat/Ret	P	9,5	6	1,08	21,50	48	51,84	1032	120x80x75
30*60 (12"*24") Lap/Ret	P	9,5	6	1,08	22,50	48	51,84	1080	120x80x75
60*119,5 (24"*47½") Forest Lap/Ret	P	9,5	2	1,434	31,00	30	43,02	930	120x80x75
60*119,5 (24"*47½") Cluster Nat/Ret	P	9,5	2	1,434	31,00	30	43,02	930	120x80x75
30*60 (12"*24") Cave Nat/Ret	P	9,5	6	1,08	22,50	40	43,2	900	120x80x75
Pezzi Speciali / Special Pieces									
33*119,5 (13"*47½") Gradino Costa Retta Nat/Ret - Lap/Ret	P	9,5	2	0,789	18,50	20	-	-	-
4,5*60 (1½"*24") Battiscopa Nat/Ret - Lap/Ret	P	9,5	14	0,378 m.l. 8,40	8,00	80	-	-	-
1,5*119,5 (½"*47½") Bacchetta Jolly Nat/Ret - Lap/Ret	P	9,5	6	0,108	2,50	48	-	-	-
1,5*1,5 (¾"*¾") Unghia Jolly Nat/Ret - Lap/Ret	P	9,5	6	0,001	0,50	48	-	-	-

Pezzi Speciali

Special pieces
Formstücke
Pièces spéciales

Battiscopa Nat/Ret 4,5×60 – 1¼”×24” ± 9,5
Battiscopa Lap/Ret 4,5×60 – 1¼”×24” ± 9,5

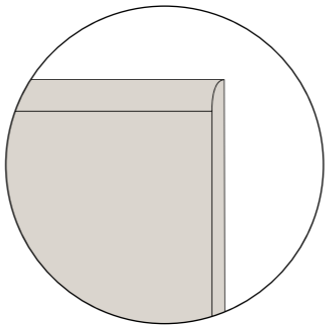
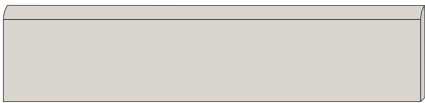

Gradino Costa Retta Nat/Ret 33×119,5 – 13”×47½” ± 9,5
Gradino Costa Retta Lap/Ret 33×119,5 – 13”×47½” ± 9,5
(costa retta ottenuto per taglio e incollaggio - obtained by cutting and gluing)

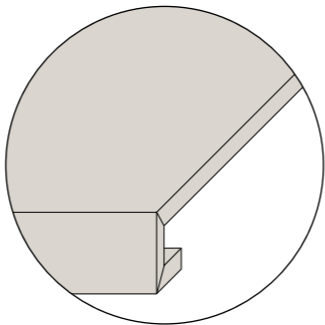
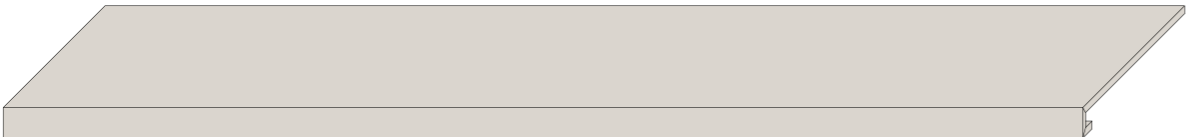

Pezzi Speciali

Special pieces
Formstücke
Pièces spéciales

Bacchetta Jolly Nat/Ret 1,5×119,5 – 5/8”×47½” ± 9,5
Bacchetta Jolly Lap/Ret 1,5×119,5 – 5/8”×47½” ± 9,5

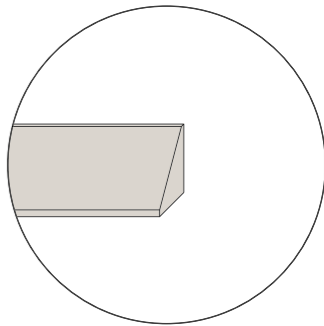
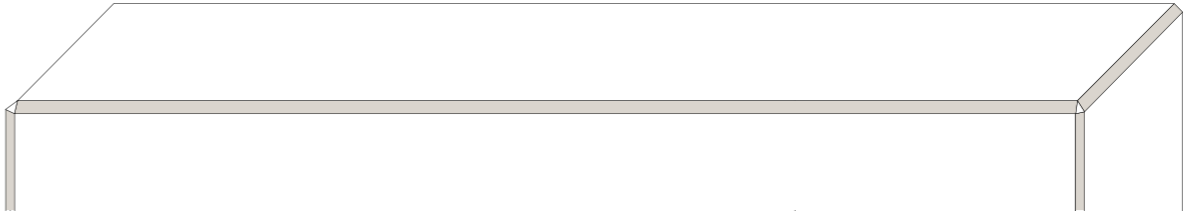

Unghia Jolly Nat/Ret 1,5×1,5 – 5/8”×5/8” ± 9,5
Unghia Jolly Lap/Ret 1,5×1,5 – 5/8”×5/8” ± 9,5

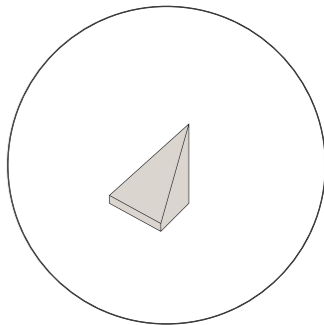
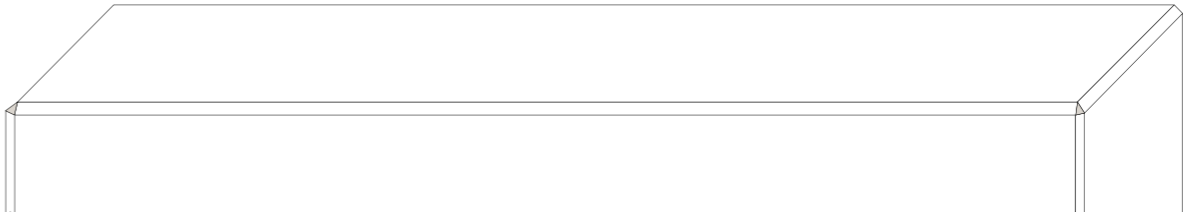

Elementi di Raccordo Bacchetta e Unghia Jolly

Universal Bevel Filler Strip and Corner Filler Chip
Verbindungselemente Universalleiste und -aussenecke
Éléments de raccord baguette et onglet Jolly



Angoli Muretti / Wall Bevel Corners / Ecke für Zwischenwände / Angles murets



Spigoli Scale / Staircase Bevel Edge / Kanten für Treppen / Arêtes escaliers

Caratteristiche Tecniche

Technical characteristics
Technische daten
Caracteristiques techniques

CLASSIFICAZIONE SECONDO NORME EN 14411 BI_A – ISO 13006 – CLASSIFICATION IN ACCORDANCE WITH EN 14411 BI_A – ISO 13006
KLASSIFIZIERUNG GEMÄSS NORMEN EN 14411 BI_A – ISO 13006 – CLASSIFICATION SELON LES NORMES EN 14411 BI_A – ISO 13006

CARATTERISTICA TECNICA TECHNICAL CHARACTERISTIC TECHNISCHE DATE CARACTÉRISTIQUE TECHNIQUE	NORMA NORM NORME	VALORE PRESCRITTO VALUE REQUIRED NORMVORGABE VALEUR PRESCRIPTE	VALORE MEDIO MEAN VALUE MITTELWERT VALEUR MOYENNE CERAMICHE PIEMME FLOOR AND MORE	NORMA NORM NORME	VALORE MEDIO MEAN VALUE MITTELWERT VALEUR MOYENNE CERAMICHE PIEMME FLOOR AND MORE
LUNGHEZZA E LARGHEZZA LENGHT AND WIDTH / LANGE UND BREITE / LONGUEUR ET LARGEUR		±0,6% (±2,00 MM)			
SPESORE THICKNESS / STÄRKE / EPAISSEUR		±5% (±0,5 MM)			
RETTILINEITÀ LATI WARPAGES OF EDGES / GERADHEIT DER KANTEN / RÉCTITUDE DES ARÊTES	ISO 10545.2	±0,5% (±15 MM)	CONFORME IN ACCORDANCE ERFÜLLT CONFORME	ASTM C-499 ASTM C-485 ASTM C-502	IN ACCORDANCE
ORTOGONALITÀ WEDGING / RECHTWINKLIGKEIT / ORTHOGONALITÉ		±0,5% (±2,00 MM)			
PLANARITÀ FLATNESS / PLANITÄT / PLANIMÉTRIE		±0,5% (±2,00 MM)			
ASSORBIMENTO % D'ACQUA WATER ABSORPTION WASSERANFNUMME % ABSORPTION D'EAU %	ISO 10545.3	≤ 0,5%	CONFORME IN ACCORDANCE ERFÜLLT CONFORME	ASTM C-373	IN ACCORDANCE
RESISTENZA ALLA FLESSIONE BENDING STRENGTH BIEGEZUGFESTIGKEIT RÉSISTANCE À LA FLEXION	ISO 10545.4	Modulus of rupture (average): R ≥ 35N/mm ² Breaking strength for thickness ≥ 7,5 mm S > 1500 N	CONFORME IN ACCORDANCE ERFÜLLT CONFORME	ASTM C-648 250 LBS OR GREATER	IN ACCORDANCE
DILATAZIONE TERMICA LINEARE TRA 20° E 100° C LINEAR THERMAL EXPANSION BETWEEN 20° AND 100° C LINEARE WÄRMEAUSENDENUNG ZWISCHEN 20° UND 100° C DILATATION THERMIQUE LINEAIRE ENTRE 20° ET 100° C	ISO 10545.8	SECONDO I DATI DEL COSTRUTTORE ACCORDING TO BUILDER'S SPECIFICATIONS LAUT ANGABEN DES HERSTELLERS SELON LES ELEMENTS DU COSTRUCTEUR	= 7x10 ⁻⁶ C ⁻¹		
RESISTENZA AGLI SBALZI TERMICI THERMAL SHOCK RESISTANCE TEMPERATURWECHSELBESTÄNDIGKEIT RÉSISTANCE AUX ÉCARTS DE TEMPÉRATURE	ISO 10545.9	RICHIESTA REQUEST BITTE DEMANDE	RESISTENTE RESISTANT WIDERSTEHEND RÉSISTANT		
RESISTENZA AL GELO FROST RESISTANCE FROSTBESTÄNDIGKEIT RÉSISTANCE AU GEL	ISO 10545.12	RICHIESTA REQUEST BITTE DEMANDE	RESISTENTE RESISTANT WIDERSTEHEND RÉSISTANT	ASTM C-1026	IN ACCORDANCE
RESISTENZA ALL'ATTACCO CHIMICO RESISTANCE TO CHEMICAL ATTACK BESTÄNDIGKEIT GEGEN CHEMIKALIEN RÉSISTANCE À L'ATTAQUE CHIMIQUE	ISO 10545.13	SECONDO I DATI DEL COSTRUTTORE ACCORDING TO BUILDER'S SPECIFICATIONS LAUT ANGABEN DES HERSTELLERS SELON LES ELEMENTS DU COSTRUCTEUR	RESISTENTE RESISTANT WIDERSTEHEND RÉSISTANT	ASTM C-650	IN ACCORDANCE
RESISTENZA DEI COLORI ALLA LUCE COLOURS RESISTANCE TO LIGHT LICHTBESTÄNDIGKEIT RÉSISTANCE DES COULEURS À LA LUMIÈRE	DIN 51094	NESSUNA ALTERAZIONE NO ALTERATION KEINE VERÄNDERUNG AUCUNE ALTERATION	CONFORME IN ACCORDANCE ERFÜLLT CONFORME		
RESISTENZA ALLE MACCHIE STAIN RESISTANCE FLECKENFESTIGKEIT RÉSISTANCE AUX TACHES	ISO 10545.14	≥ CLASSE 3 METODO DI PROVA DISPONIBILE TEST METHOD AVAILABLE VERFÜGBARE PRÜFMETHODE METHODE D'ESSAI DISPONIBLE	CONFORME IN ACCORDANCE ERFÜLLT CONFORME		
RESISTENZA ALLO SCIVOLAMENTO SLIPPAGE RESISTANCE RUTSCHSICHERHEIT RÉSISTANCE AU GLISSEMENT	DIN 51130 *	9 ≤ R ≤ 13	NAT R10 LAP	ASTM C-1028 * COF ≥ 0,6 DRY ≥ 0,6 WET	NAT LAP GRIP
	DIN 51097 *	A,B,C	NAT A+B LAP	ANSI * 137,1-2012 DCOF > 0,42 WET	NAT > 0,42 LAP 0,42 GRIP > 0,42
	BS EN 7976-2*	> 36 DRY > 36 WET	NAT Dry/Wet + 36 LAP GRIP	AS 4586-2013 CLASS	NAT P3 LAP GRIP P4

*TRATTANDOSI DI NORMATIVE NAZIONALI, I METODI DI PROVA, I REQUISITI E LE CLASSIFICAZIONI VARIANO DA PAESE A PAESE. IL VALORE ATTESO DALLA RESISTENZA ALLO SCIVOLAMENTO DELLA PRODUZIONE DI INDUSTRIE CERAMICHE PIEMME S.P.A., PUÒ VARIARE IN BASE AL LOTTO PRODUTTIVO. SPECIFICA DOCUMENTAZIONE È DISPONIBILE SU RICHIESTA.
TEST METHODS, REQUIREMENTS AND CLASSIFICATIONS DIFFER FROM COUNTRY TO COUNTRY, ACCORDING TO THE NATIONAL REGULATIONS. THE EXPECTED VALUE OF SLIPPAGE RESISTANCE OF PRODUCTS BY INDUSTRIE CERAMICHE PIEMME S.P.A. MAY VARY DEPENDING ON THE PRODUCTION BATCH. SPECIFIC DOCUMENTS ARE AVAILABLE UPON REQUEST.
PRÜFVERFAHREN, ERFORDERNISSE UND KLASSIFIKATIONEN SIND VERSCHIEDEN VON LAND ZU LAND, GEMÄSS DER NATIONALEN VORSCHRIFTEN. DER ERWARTUNGSWERT DER RUTSCHSICHERHEIT DER PRODUKTE VON INDUSTRIE CERAMICHE PIEMME S.P.A. KANN SICH - JE NACH DER PRODUKTIONSPARTIE - VERÄNDERN. SPEZIFISCHE UNTERLAGEN SIND AUF VERLANGEN ZUR VERFÜGUNG.
LES MÉTHODES D'ESSAI, LES RÉQUISITIONS ET LES CLASSIFICATIONS CHANGENT DE PAYS À PAYS, SELON LES RÉGLEMENTATIONS NATIONALES. LA VALEUR ATTENDUE DE RÉSISTANCE AU GLISSEMENT DES PRODUITS DE INDUSTRIE CERAMICHE PIEMME S.P.A. PEUT VARIER EN FONCTION DU LOT DE PRODUCTION. UNE DOCUMENTATION SPÉCIFIQUE EST DISPONIBLE SUR DEMANDE.

ELENCO DELLE SERIE CERTIFICATE E CLASSIFICAZIONI DISPONIBILI A RICHIESTA - LIST OF CERTIFIED SERIES AND CLASSIFICATIONS AVAILABLE UPON REQUEST
LISTE DER GEPRÜFTEN SERIE UND KLASSIFIZIERUNGEN AUF ANFRAGE ERHÄLTlich - LISTE DES SERIES CERTIFIÉES ET DES CLASSEMENTS DISPONIBLES SUR DEMANDE



CERAMICHE PIEMME
FLOOR AND MORE



Norme per la posa e la manutenzione

Installation and maintenance instructions
Verlegung, reiningung und pflege
Guide a la pose et l'entretien

TIPO DI SPORCO	INDICAZIONI PER LA PULIZIA
Birra, Caffè, Gelato, Vino Gomma Pneumatico, Grassi vegetali e animali, Inchiostri, Lampostili Olii Meccanici, Residui di scotch Ollo di lino, Pennarello Resine Smalti, Tintura per capelli	Prodotti a Base Alcalina
Cera protettiva anti-abrasione, Depositi calcarei, Macchie di ruggine	Prodotti a Base Acida
Cera di candela, Residui di scotch	Solventi
Per ulteriori informazioni specifiche consultare l'area tecnica sul sito Piemme: www.ceramichepiemme.it	

TYPE OF STAIN	CLEANING SUGGESTIONS
beer, coffee, wine, ice cream vegetable and animal fats, rubber, remains of scotch tape, grease from machines, linseed oil, felt tip pens, paints, inks, hair dye	Alkaline-based detergent
protective anti-abrasion wax, calcareous residuals, rust stains	Acid-based detergent
candle wax, remains of scotch-tape	Solvents
For further specific details please visit the technical area on Piemme website: www.ceramichepiemme.it	

VERSCHMUTZUNGSART	REINIGUNGSHINWEISE
Bier, Wein, Eis, Kaffee Tierische oder pflanzliche Fette Gummi, Kleberbandresten Schmieröl, Tinte, Leilöl, Filzstift, Harz oder Lack, Haarfarbe	Alkalische Reinigungsmittel
Kratzenschutz-Wachs, Kalkablagerunge, Rostflecken	Säure-Reinigungsmittel
Kerzenwachs Kleberbandresten	Lösungsmittel
Weitere Einzelheiten finden Sie in dem technischen Bereich des Piemme website: www.ceramichepiemme.it	

TYPE DE TACHE	NETTOYAGE CONSEIL
Bière, Vin, Glace, Café, Graisses végétales et animales, Encres, Résidus de scotch, Huile de graisse, Hile de lin Crayon feutre Emaux, Teinture pour cheveux, Caoutchouc pour pneus	Détergents à base alcaline
Cire de protection anti abrasion, Dépôts de calcaire, Tache de rouille	Détergents à base d'acide
Cire de bougie Résidus de scotch	Solvant
Pour d'ultérieures Information spécifiques consulter le département technique du site Piemme: www.ceramichepiemme.it	

- Per i prodotti rettificati consigliamo una fuga di 2 mm per un migliore risultato di posa.
- Per una migliore resa estetica Piemme consiglia stuccature colorate in tinta con le piastrelle. Verificare, prima dell'utilizzo, la compatibilità ed idoneità dei riempitivi per fughe con il prodotto ceramico.
- Rimuovere le eccedenze dei riempitivi per fughe quando gli stessi sono ancora freschi.
- Attenersi scrupolosamente alle istruzioni indicate dai produttori dei riempitivi per fughe.
- Per eliminare completamente i residui di posa, che potrebbero compromettere la manutenzione ordinaria e le caratteristiche del prodotto, a posa ultimata, procedere con la pulizia utilizzando prodotti adeguati, a base Acida max 3%, rispettando le indicazioni del produttore. Osservare assolutamente i limiti di tempo indicati nelle istruzioni: un contatto troppo prolungato con questi prodotti potrebbe provocare il danneggiamento della superficie.
- Gli eventuali aloni che si dovessero presentare dopo la posa di materiali lappati o levigati si potranno facilmente eliminare utilizzando un prodotto idoneo, a base Alcalina.
- Riguardo l'utilizzo di materiali ceramici all'esterno, pure riconfermando l'ingelività dei prodotti Piemme in gres porcellanato, in conformità alle vigenti normative europee EN 14411/ISO 13006-ISO 10545.12, occorre attenersi ad alcune fondamentali norme previste per la posa all'esterno, atte a rendere inattaccabili al gelo i predetti pavimenti. Le condizioni più importanti da rispettare sono: le opportune pendenze, le impermeabilizzazioni, i giunti di dilatazione, e l'uso di idonei materiali per la posa.
- Decorazioni realizzate con smalti e metalli preziosi è indispensabile proteggere la superficie durante la posa, non utilizzare assolutamente prodotti abrasivi e/o acidi, ma solo acqua e sapone neutro. Il produttore non risponde di eventuali danni a questi preziosi materiali causati da "sfregamenti" durante la posa in opera. Per nessun motivo saranno accettate contestazioni relative a materiale posato.

- For better installation results of rectified products, we suggest 2 mm joint.
- For a better aesthetic finish, Piemme recommends using jointing colours that match the tiles.
- Please check, before using, the compatibility and suitability of grouting material with the ceramic tile.
- Clean away the excess of grouting materials while they are still fresh.
- Follow carefully the instructions pointed out by the producers of tile grouting materials.
- To completely eliminate installation residues, which could negatively affect routine maintenance and product characteristics once installation has terminated, proceed to clean using adequate products, with max. 3% Acid base, following the manufacturer's instructions. Always closely abide by the time limits indicated in the instructions: prolonged contact with these products may cause damage to the surface.
- Any rims that appear after installing lapped or polished materials can be easily eliminated using a suitable Alkaline-based product.
- With regard to the use of ceramic materials outdoors, while once more reiterating that Piemme porcelain stoneware products are frost-proof, in compliance with applicable European standards EN 14411/ISO 13006-ISO 10545.12, a number of fundamental procedures must be followed for outdoor installation, suitable for making the aforementioned floors resistant to frost. The most important aspects are: suitable gradients, waterproofing, expansion joints, and the use of suitable installation materials.
- Decorations made with glazes and precious metals It is most important to protect the surface during installation. Never use abrasive and/or acid products, only water and neutral soap. The manufacturer disclaims liability in case of any damage to these precious materials caused by "rubbing" during installation. Under no circumstances will disputes be accepted relating to the installed material.

- Damit sich eine bessere Verlegung von geschliffenen Produkten ergibt, empfehlen wir eine Fugenbreite von 2 mm. Für ein optisch perfektes Ergebnis empfiehlt Piemme, die Fugen farblich auf die Fliesen abzustimmen.
- Prüfen sie bitte, vor der Verwendung, die Zweckmäßigkeit und die Verträglichkeit des Fugenfüllmittels mit den Keramikfliesen.
- Bitte entfernen sie das überflüssige Fugenfüllmittel wenn es noch frisch ist.
- Folgen sie bitte sorgfältig die von dem Herstellern des Fugenfüllmittels angegebenen Bedienungsvorschriften.
- Zur vollkommenen Entfernung der Verlegerückstände, die die normale Pflege erschweren und die Merkmale des Produkts beeinträchtigen könnten, nach der Verlegung geeignete Reinigungsmittel auf max. 3% Säurebasis verwenden und bei der Reinigung die Hinweise des Herstellers beachten. Die angegebenen Zeiten keinesfalls überschreiten: ein zu lange andauernder Kontakt mit diesen Produkten kann Beschädigungen der Oberfläche verursachen.
- Eventuelle nach der Verlegung von gelapptem oder geschliffenem Material sichtbare Schleier lassen sich einfach mit entsprechenden, alkalischen Produkten entfernen.
- Auch wenn die Piemme-Feinsteinzeugprodukte gemäß den europäischen Normen EN 14411/ISO 13006-ISO 10545.12 frostbeständig sind, müssen beim Einsatz keramischer Materialien im Freien einige Grundregeln beachtet werden, damit die Bodenbeläge nicht vom Frost angegriffen werden können. Die wichtigsten Voraussetzungen sind: korrektes Gefälle, Abdichtung, Dehnungsfugen sowie geeignetes Verlegematerial.
- Dekore mit Glasuren und Edelmetallen Während der Verlegung muss die Oberfläche unbedingt abgedeckt werden. Es dürfen keine scheuernden und/oder säurehaltigen Produkte verwendet werden, sondern ausschließlich Wasser und neutrale Seife. Der Hersteller haftet nicht für eventuelle, während der Verlegung durch Abrieb entstandene Schäden an diesen hochwertigen Materialien. Reklamationen von bereits verlegtem Material werden in keinem Fall akzeptiert.

- Pour obtenir le meilleur résultat de pose de produits rectifiés, il est conseillé de réaliser un joint de 2 mm.
- Pour parfaire l'effet esthétique obtenu, Piemme conseille de confectionner des joints de la même couleur que les carreaux.
- Vérifier avant la pose la compatibilité et convenance des remplissages pour joints avec le produit céramique.
- Enlever les surplus des remplissages pour joints alors qu'ils sont encore frais.
- Respecter scrupuleusement les instructions indiquées par les fabricants de remplissages pour joints.
- Pour éliminer complètement tout résidu de pose pouvant gêner l'entretien courant et altérer les caractéristiques du produit, il est conseillé, à la fin de la pose, de procéder au nettoyage du carrelage avec des produits à base acide maximum 3% et de respecter les consignes du fabricant. Suivre impérativement les délais indiqués dans la notice car le contact trop prolongé de ces produits pourrait endommager la surface.
- Pour éliminer facilement la présence éventuelle de cernes après la pose de carreaux rodés ou polis, utiliser un produit à base alcaline.
- Pour ce qui est de la pose à l'extérieur, bien que les produits Piemme en grès cérame soient ingélifs, conformément aux normes européennes EN 14411/ISO 13006-ISO 10545.12, il convient cependant de respecter quelques règles fondamentales de manière à rendre le carrelage inattaquable au gel. Les conditions les plus importantes à remplir sont: le degré d'inclinaison, l'imperméabilisation, les joints de dilatation et l'utilisation de matériaux de pose appropriés.
- Décor réalisés avec des émaux et des métaux précieux Il est indispensable de protéger la surface pendant la pose. N'utiliser en aucun cas des produits abrasifs et/ou acides mais uniquement de l'eau et du savon neutre. Le fabricant ne répond pas des dommages éventuels de ces matériaux précieux causés par le frottement pendant la pose. Aucune réclamation, quelle qu'elle soit, concernant le matériau posé ne sera acceptée.

Reading Guide
Leseanleitung
Guide à la lecture

 Spessore
Thickness
Stärke
Épaisseur

Variazione nelle sfumature di colore
Color shade variations
Variation der Farbnuancen
Variation des nuances de couleur

Resistenza alla scivolosità
Skid resistance
Rutschfestigkeit
Resistance au glissement

 V1 Aspetto uniforme
Uniform appearance
Gleichförmiges aussehen
Aspect uniforme

 V2 Variazione leggera
Slight variation
Leichte variation
Variation légère

 V3 Variazione moderata
Moderate variation
Mäßige variation
Variation modeste

 V4 Variazione casuale
Random variation
Zufällige variation
Variation fortuite

DIN 51130	DIN 51097	DCOF
R10	A+B	>0,42

Tutti i formati sono nominali.

All sizes are nominal.

Die Formate sind Nennwerte.

Tous les formats sont nominaux.

Gli spessori riportati in questo catalogo sono nominali e possono variare a seconda dei formati e delle finiture.

The thickness mentioned on this catalogue are nominal and can be different according to the sizes and the finishes.

Die in diesem Katalog angegebenen Fliesenstärke sind nominal und können, je nach Format oder Oberfläche, verschieden sein.

Les épaisseurs reportées sur ce catalogue sont nominales et peuvent varier suivant les formats et les finitions.

I colori e le caratteristiche estetiche dei prodotti sono quanto più possibile vicini a quelli reali, nei limiti consentiti dai processi di stampa.

The colours and appearance features of the products are as close as possible to reality, within the limitation of the printing process.

Die Farben und die ästhetischen Eigenschaften der Produkte entsprechen der Wirklichkeit, innerhalb den von dem Druckverfahren erlaubten Grenzen.

Les couleurs et les caractéristiques esthétiques sont fidèles aux couleurs et caractéristiques réelles dans les limites des procédés d'impression.



Ceramics of Italy

Ceramics of Italy rappresenta la volontà dell'industria italiana delle piastrelle di ceramica nel diffondere e promuovere una nuova valenza della piastrella di ceramica: non più solo un prodotto per l'industria delle costruzioni, ma punto di riferimento per stile e creatività per lo sviluppo di una nuova cultura dell'abitare Made in Italy.

Ceramics of Italy represents the willingness of the Italian ceramic tile industry to spread and promote a new concept of ceramic tile: no longer just a product for the construction industry, but a focal point for style and creativity in the development of a new culture of living Made in Italy.

Una storia tutta italiana

Piemme dal 1962, anno della sua fondazione, è protagonista indiscussa del vero Made in Italy, quello fatto di eccellenza, passione e creatività. Oggi tutti i materiali Piemme sono prodotti con tecnologia d'avanguardia come la decorazione digitale inkjet HD, la cottura in forni ad energia pulita a recupero di calore, la rettifica e levigatura in linea "one roof" e la verifica elettronica dello standard qualitativo.

An all-Italian story

Since 1962, the year of its foundation, Piemme has been the undisputed protagonist of real Made in Italy, that which consists of excellence, passion and creativity. Today, all Piemme materials are made using cuttingedge technology such as HD inkjet digital decoration, firing in heat-recycling cleanenergy kilns, "one roof" grinding and polishing line and electronic quality standard control.

Eine ganz italienische Geschichte

Seit dem Gründungsjahr 1962 ist Piemme ein unangefochtener Hauptakteur des echten Made in Italy: jenem, das auf Exzellenz, Leidenschaft und Kreativität gründet. Alle Piemme Erzeugnisse werden heute unter Einsatz von Spitzentechnologie produziert, wie zum Beispiel mit der digitalen Inkjet-Dekoration, dem Brennen in Öfen mit grüner Energie und Wärmerückgewinnung, dem Schleifen und Polieren in der Linie „unter einem Dach“ sowie der elektronischen Prüfung des Qualitätsniveaus.

Une histoire toute italienne

Depuis 1962, l'année de sa fondation, Piemme est la protagoniste indiscutée du Made in Italy, basé sur l'excellence, la passion et la créativité. Aujourd'hui toutes les phases du cycle de fabrication Piemme sont issues d'une technologie à l'avant-garde comme la décoration numérique inkjet HD, la cuisson dans des fours à énergie propre et à récupération de chaleur, la rectification et le polissage en en ligne "one roof" et la vérification électronique de la qualité.

CERAMICHE PIEMME

FLOOR AND MORE

INDUSTRIE CERAMICHE PIEMME S.P.A.
VIA DEL CROCIALE 42/44, 41042 FIORANO (MO) - ITALY
T. +39 0536.849111 - F. +39 0536.849402
WWW.CERAMICHEPIEMME.IT - INFO@CERAMICHEPIEMME.IT